

DUAL DISPLAY L/C/R METER

ELC-132A/ELC-133A USER MANUAL

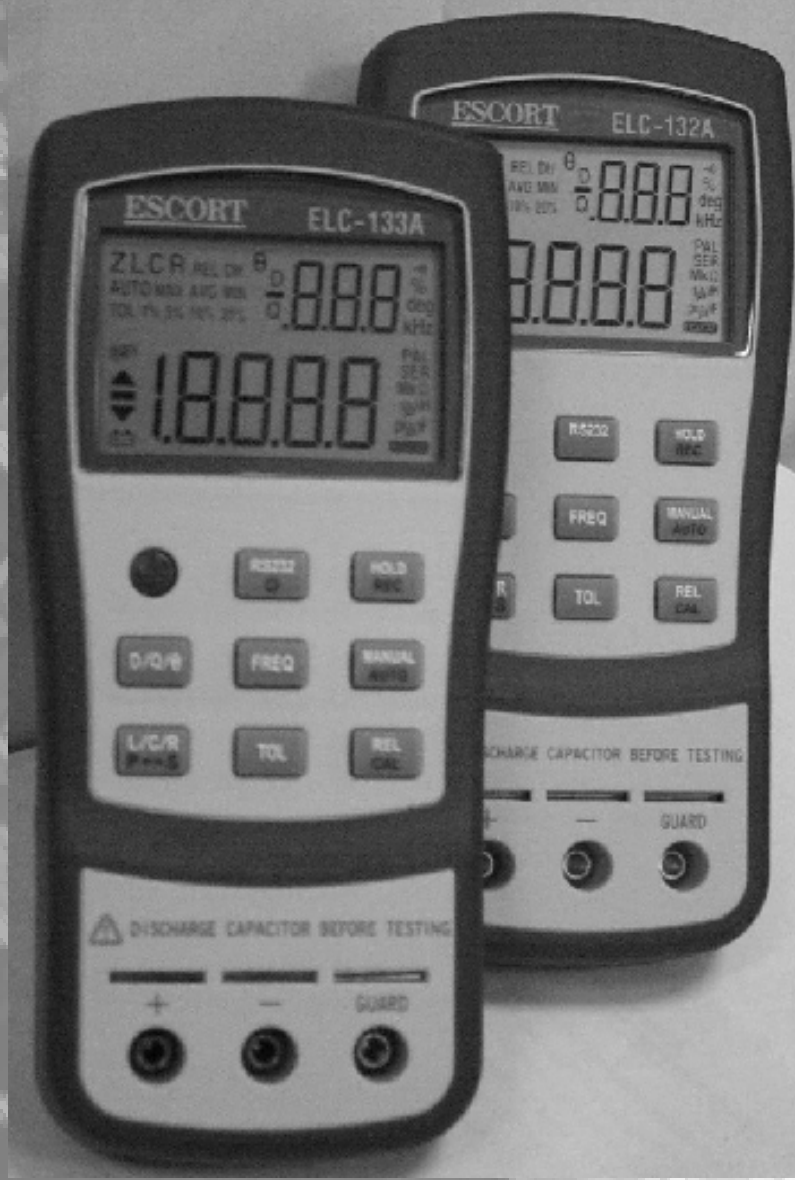

ATTENTION

***In this instruction manual,
The ELC-133A is represented with Model-A.
The ELC-132A is represented with Model-B.***

Items	Model-A	Model-B
	ELC-133A	ELC-132A
Parameters Measured	L/C/R/D/Q/	L/C/R/D/Q
Measuring Circuit Mode	Inductance (L) –Defaults to series mode Capacitance/ Resistance (C/R) -Defaults to parallel mode	
Displays	L/C/R: <i>Maximum</i> display 19999 D/Q: Maximum display 999 (Auto Range).	
Ranging Mode	Auto & Manual	
Measuring Terminals	3 terminals with sockets	
Test Frequency Accuracy: ±0.1 %	100Hz=100 Hz 120Hz= 120 Hz 1KHz =1010 Hz 10KHz= 9.6 KHz	120Hz= 120 Hz 1KHz =1010 Hz
Backlit display	Included	Excluded
Tolerance mode	1%, 5%, 10%, 20%	1%, 5%, 10%
Test Signal Level	0.6Vrms approx.	
Measuring Rate	1 time/second, nominal	
Response time	Approx. 1 second/ DUT (device under test)(@ manual range)	
Auto Power-Off	5 minutes approx. without operation	
Temperature Coefficient	0.15 x (Specified Accuracy) / (0-18 or 28-40)	
Operation Temperature	0 to 40 ; 0-70% R.H.	
Storage Temperature	-20 to +50 ; 0-80% R.H.	
Low Battery Indication	Approx. 6.8V	
Protective Fuse	0.1A/250V Fuse (input protective)	
Standard Accessories	Test alligator clips (pair) DC 9V Battery. User manual	
Optional Accessories	Carrying case RS232 package SMD Tweezers DC Adaptor (EA112: AC120V) / (EA55: AC220V).	
Dimensions (L/W/H)	184/ 87/ 41 mm	
Weight	330 grams	

DUAL DISPLAY L/C/R METER

INSTRUCTION MANUAL

Model-A

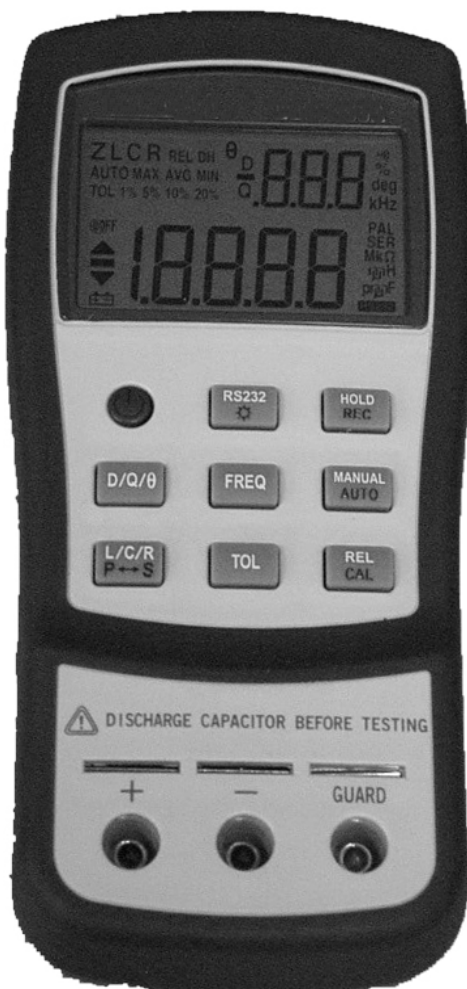

Model-B



Table of Contents

	<u>PAGE</u>
<u>Safety</u>	1
<u>Introduction</u>	3
<u>Front Panel Illustration</u>	4
<u>LCD Display Illustration</u>	5
<u>How to Operate</u>	7
<u>Operating Instructions</u>	11
<input type="checkbox"/> Data Hold	11
<input type="checkbox"/> Static Recording	11
<input type="checkbox"/> Dissipation Factor / Quality Factor/ Phase Angle	11
<input type="checkbox"/> Test Frequency	12
<input type="checkbox"/> L/C/R function selector	12
<input type="checkbox"/> Relative	12
<input type="checkbox"/> Tolerance	12
<input type="checkbox"/> Auto/manual ranging	13
<input type="checkbox"/> Automatic Fuse Detection	13
<input type="checkbox"/> Parallel / Series Mode	13
<input type="checkbox"/> Calibration	14
<input type="checkbox"/> Auto Power Off/ Disable Auto Power Off	15
<input type="checkbox"/> Low Battery Indication	15
<input type="checkbox"/> Backlit Display	15
<input type="checkbox"/> Communication	16
<u>General Specification</u>	17
<u>Electrical Specification</u>	18
<u>Maintenance</u>	26

Safety

Read "SAFETY INFORMATION" before using this meter.

□ NOTE

The meter is a hand-held, battery-operated instrument for testing inductance, capacitance and resistance. If this device is damaged or something is missing, contact the place of purchase immediately.

This manual contains information and warnings must be followed to ensure safe operation as well as to maintain the meter in a safe condition. Some common international electrical symbols used in this manual are shown below Table:



	DC - Direct Current
	See Explanation In The Manual

Table 1-1. International Electrical Symbols

Before using the meter, read the following safety information carefully. In this manual, "**WARNING**", is reserved for conditions and actions that pose hazard(s) to the user; "**CAUTION**", is reserved for conditions and actions that may damage your meter.

□ SAFETY INFORMATION

To ensure that you use this device safely, follow the safety guidelines listed below:

- This meter is for indoor use, altitude up to 2,000 m.
- The warnings and precautions should be read and well understood before the instrument is used.
- Use this device only as specified in this manual; otherwise, the protection provided by the meter may be impaired.
- When measuring in-circuit components, first de-energize the circuits before connecting to the test leads.
- Discharge capacitor before testing.
- The meter is safety-certified in compliance with EN61010 (IEC 1010-1) Installation Category II (CAT. II) 50 V, Pollution Degree 2 environment.
- Use the meter only as specified in this manual. Otherwise, the protection provided by the meter may be impaired.
- The power for the meter is supplied with a single standard 9V battery. But also a line operation is possible using a 12V AC to DC adaptor. If a power adaptor is selected, please be sure to use fulfilled the safety requirements of a relevant IEC standard.

Introduction

This 19,999-count L/C/R hand-held meter is a special microprocessor-controlled meter for measuring functions of inductance, capacitance and resistance. Extremely simple to operate, the instrument not only takes absolute parallel mode measurements, but also capable of series mode measurement. The meter provides direct and accurate measurements of inductors, capacitors and resistors with different testing frequencies. It is selectable for auto and manual ranging.

Front panel pushbuttons maximize the convenience of function and feature selection such as data hold; maximum, minimum and average record mode; relative mode; tolerance sorting mode; frequency and L/C/R selection.

The test data can be transferred to PC through an optional full isolated optical RS232C interface.

Backlight display for easy reading in dark places (Model-A only).

A tilt stand provides position flexibility for viewing and operating the meter. The over-molding rubber case protects the meter to be stronger. With single 9V battery operation is standard for the meter, a DC 12V power adaptor can also be used as an optional power input.

Front Panel Illustration

1. LCD display
2. Power ON/OFF button
3. RS232 and Backlit button
4. Dissipation factor, Quality factor and Phase angle selection button
5. Test frequency selection button
6. Inductance, Capacitance and Resistance function selection button. Parallel and series mode selection button
7. Tolerance mode selection button
8. Data hold, Maximum, Minimum and Average reading selection button
9. Range selection button
10. Relative mode and Calibration selection button
11. DC 12V adaptor input
12. Input sockets and Terminals

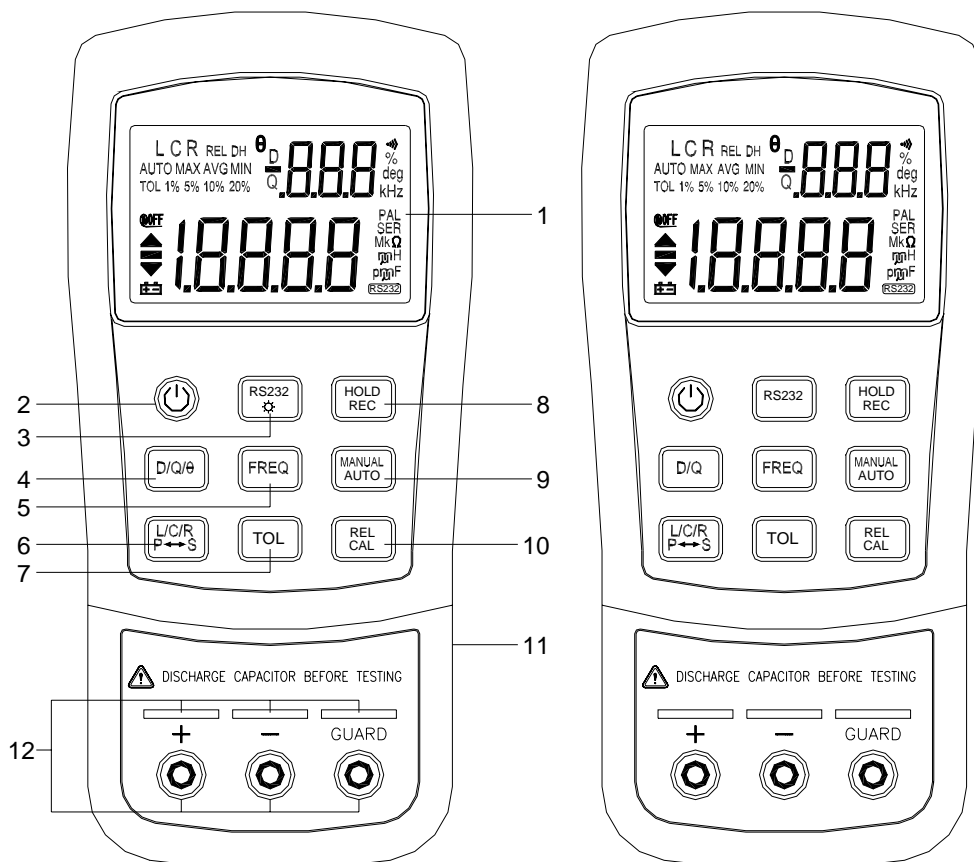

Figure-1. Front panel for Model-A and Model-B.

LCD Display Illustration

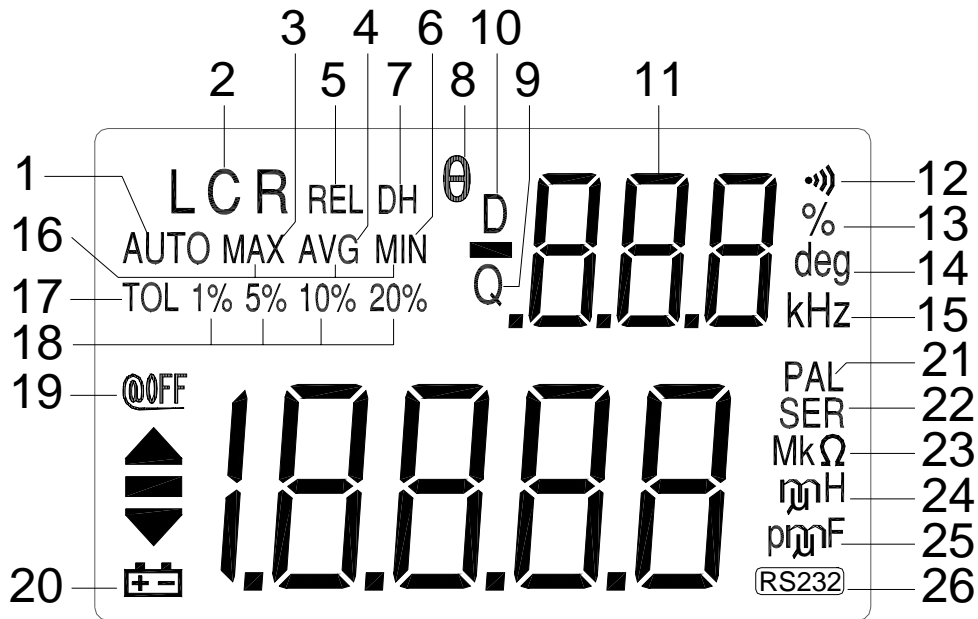







Figure 2. LCD Display.

1. **AUTO:** Auto-ranging indicator
2. **LCR:** L, C or R function indicator
3. **MAX:** Maximum reading indicator
4. **AVG:** Average reading indicator
5. **REL:** Relative mode indicator
6. **MIN:** Minimum reading indicator
7. **DH:** Data hold indicator
8. θ : Phase angle indicator (Model-A only)
9. **Q:** Quality factor indicator
10. **D:** Dissipation factor indicator
11. **0.00** : Secondary display
12. $\cdot\cdot\cdot$: Beeper tone indicator for tolerance mode
13. **%:** Tolerance (percentage) indicator
14. **deg:** Phase Angle degree indicator (Model-A only)
15. **kHz:** Frequency indicator
16. **MAX AVG MIN:** Recording mode indicators
17. **TOL:** Tolerance mode indicator
18. **1%5%10%20%:** Tolerance sorting (percent) indicator

19. : Auto power- off indicator
20. : Low battery indicator
21. **PAL**: Parallel mode indicator
22. **SER**: Series mode indicator
23. **Mk** : Resistance (Ohm) indicator
24. : Inductance (Henry) indicator
25. : Capacitance (Farad) indicator
26. : RS232 indicator

Special Indication Characters

Srt : Indicates short connectors

OPn : Indicates open connectors

CAL : Indicates calibration mode

FUSE : Indicates damaged or open fuse

How To Operate

Caution

When measuring within a circuit, the circuit must be de-energized before connecting the test leads.

The instrument that used in dusty environment should be wiped and cleaned regularly.

Do not leave the instrument exposed to direct heat from the sun or heat source for long periods.

Before removing the cover, ensure that the instrument is disconnected from any circuit and in power "OFF" position.

Note:

For achieving optimum precision for all L, C and R measurements at either the highest or lowest ranges, it is recommended to calibrate the meter before testing.

□ Inductance Measurement

1. Press the "**POWER**" button to turn on the meter.
2. Press "**L/C/R**" button to select inductance measurement.
3. Insert an inductor into component receptacle socket or connect the test clip to the component leads as required.
4. Press "**FREQ**" button to select testing frequency.
5. Press "**D/Q**" button to select Q factor for secondary display.
6. Read the display readings for inductance value and quality factor.

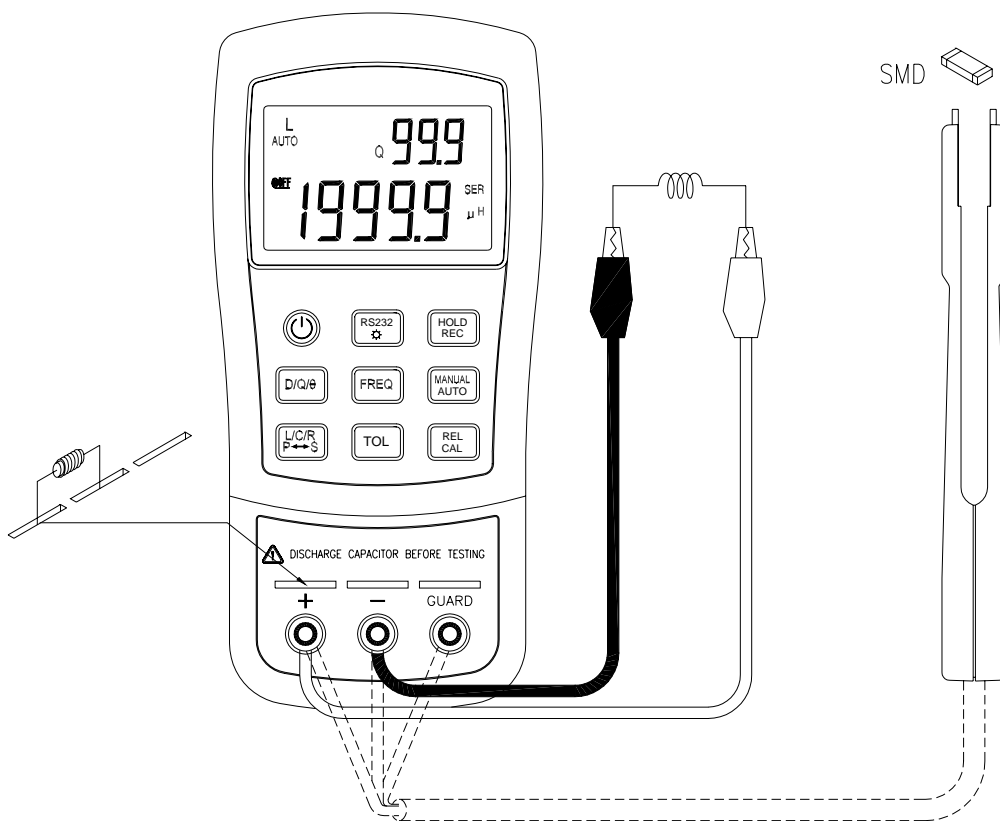

Figure-3. Inductance Measurement.

□ Capacitance Measurement

1. Press "**POWER**" button to turn on the meter.
2. Press "**L/C/R**" button to select capacitance measurement.
3. Insert a capacitor into the component receptacle socket or connect the test clip to the component leads as required.
4. Press "**FREQ**" button to select testing frequency.
5. Press "**D/Q**" button to select D factor for secondary display.
6. Read the display readings for capacitance value and dissipation factor.

⚠ Warning

To avoid electrical hazards, discharge the capacitor to be tested before measuring.

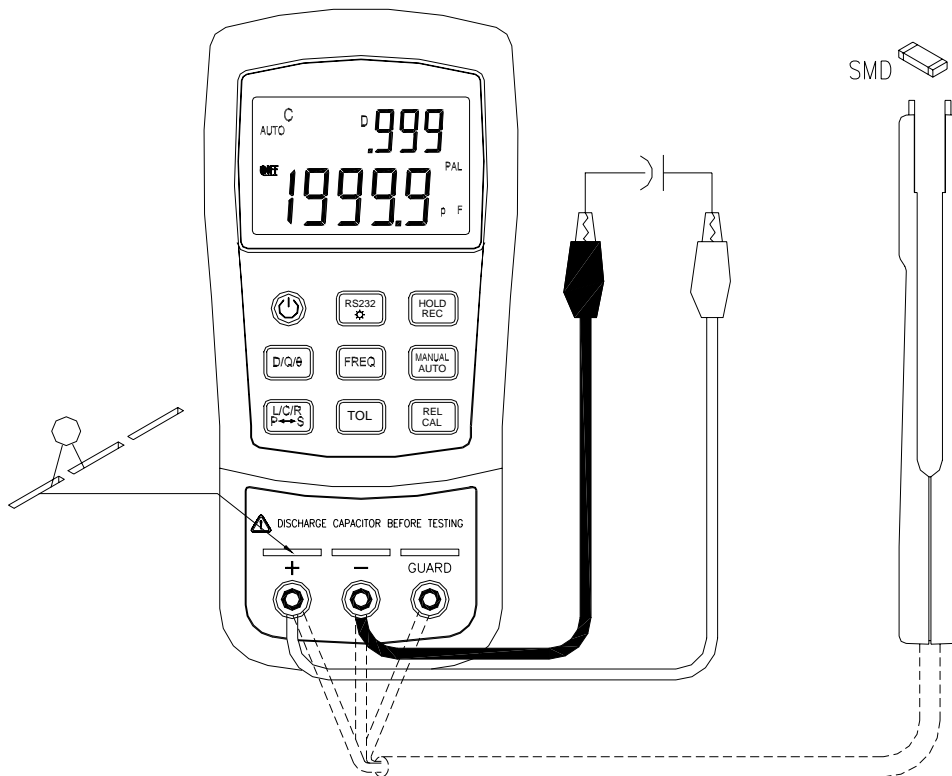

Figure-4. Capacitance Measurement.

□ Resistance Measurement

1. Press "**POWER**" button to turn on the meter.
2. Press "**L/C/R**" button to select Resistance measurement.
3. Insert a resistor into the component receptacle socket or connect the test clip to the component leads as required.
4. Press "**FREQ**" button to select testing frequency.
5. Read the display readings for resistance value.

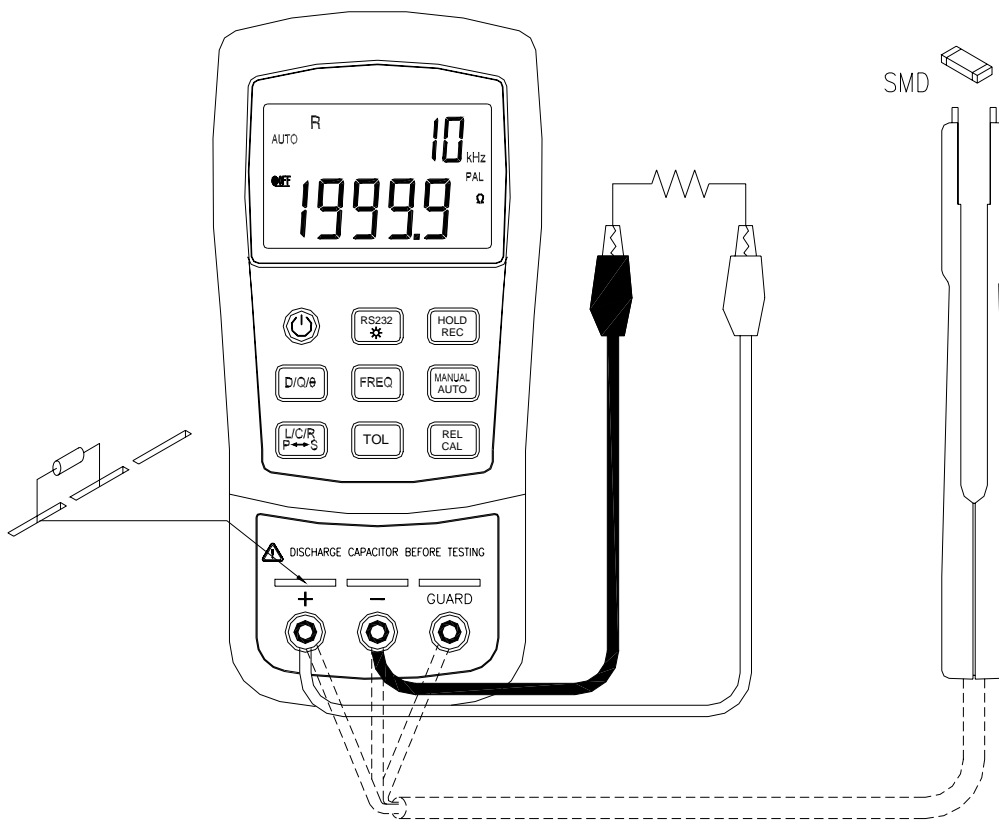

Figure-5. Resistance Measurement.

Operating Instructions

□ Data Hold

This data hold function allows the operator to freeze the display. To enter this mode, press the "**HOLD**" pushbutton; press again to release.

□ Static Recording™

Press the "**REC**" pushbutton for more than one second to enter the static recording mode. The maximum and minimum readings are then stored in memory, while a beeping tone is produced when a new tested value has been recorded. Push the same button to cycle through the maximum, minimum and average of the present readings. The **MAX**, **MIN** or **AVG** indicators will display on LCD will turn on to indicate what value is being displayed. Whenever the "**MAX AVG MIN**" indicators appear on the LCD simultaneously, the display reading is always a present value. To exit this mode, press and hold the pushbutton for more than one second.

Notes:

1. Static recording captures only stable values and updates the memory; it will not record any "**OL**" (overload) value for any of the **L/C/R** functions. In addition, the meter will not record which values are below 50 counts in Capacitance measurement.
2. Static recording is only available in manual ranging; however, activation while in auto-ranging will automatically set meter to manual ranging and cause calibration prompts to be displayed in the recommended ranges.

□ Dissipation Factor / Quality Factor/ Phase Angle

The "**D/Q/** " value can be displayed interchangeably by pressing the "**D/Q/** " button when the meter is set to Inductance or Capacitance mode. It does not apply to resistance measurement. The phase angle is available on Model-A only.

□ Test Frequency

Default testing frequency is 1KHz. Push "**FREQ**" key to select the desired test frequency.

□ L/C/R Function Selector

Simply press the "**L/C/R**" pushbutton to select the desired L, C or R function.

□ Relative

Press the "**REL**" key to enter the relative mode and stores the display reading as a reference value. It will then display all subsequent readings in relative to reference value. Press the button again to exit the relative mode.

Notes:

1. The relative mode can't be activated if the display value is either "**OL**" or "**0000**".
2. Relative mode is only available in manual ranging; however, activation while in auto-ranging will automatically set the meter to manual ranging and cause calibration prompts to be displayed in the recommended ranges.
3. The relative mode cannot be activated if the meter is set at auto-ranging with data hold activated.

□ Tolerance

There are 1%, 5%, 10% and 20% tolerance range. To enter this tolerance mode, insert the appropriate component as a standard value into the socket or connect the component to the test probes, then press the "**TOL**" pushbutton to set this value, as the standard reference tolerance. Similarly, any value which appears on the LCD display, such as **DH** or **MAX/MIN/AVG**, can be used as a standard value to sort components. Press this button again to cycle through 1%, 5%, 10% and 20% tolerance as desire.

This function is designed for convenient component sorting. An audible tone of "Be-Be-Be" will sound whenever the component under test exceeds the setting tolerance. Conversely, a single tone of "Be" indicates the component is within the setting tolerance.

Notes:

1. The tolerance mode can't be activated if the tested display is either "**OL**" or "**0000**"; nor can it be activated the tested capacitance value is below 10 counts.
2. Tolerance mode is only available in manual ranging; however, activation while in auto-ranging will automatically set the meter to manual ranging and cause calibration prompts to be displayed in the recommended ranges.
3. The tolerance mode can't be activated if the meter is set at auto-ranging with data hold mode activated.
4. For 20% selection is available on Model-A only.

□ Auto / Manual Range

The auto-ranging mode is default status when the meter is powered on. For specific measurement, press "**AUTO**" button to select manual ranging. To return to the auto-ranging mode, press and hold the "**AUTO**" button for more than one second.

□ Automatic Fuse Detection

When the meter detects that the protective fuse is open, the "**FUSE**" character will appear and an internal beep will sound continuously. In this situation, none of the function keys can be operated and all other meter functions will be discontinued. Fuse replacement is required.

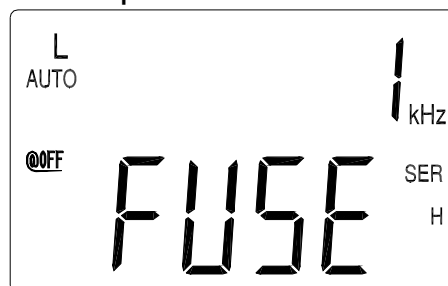

Figure-6. Fuse Detection

□ Parallel / Series Mode

The meter is capable of displaying Parallel and Series mode data for all ranges. The parallel mode is default for Capacitance and Resistance measurements, and the series mode is default for Inductance measurement. Press "**L/C/R**" button for more than 1 second to toggle "**SER**" and "**PAL**" mode.

□ Calibration

Calibration is available to all ranges. Simply press and hold "CAL" button for more than one second to enter the calibration mode and calibration prompts will be displayed. Follow the prompts for open connector (OPn) or short connector (Srt) connection and press the "CAL" button. After calibration is completed, the meter will be restored to normal display and ready for normal usage.

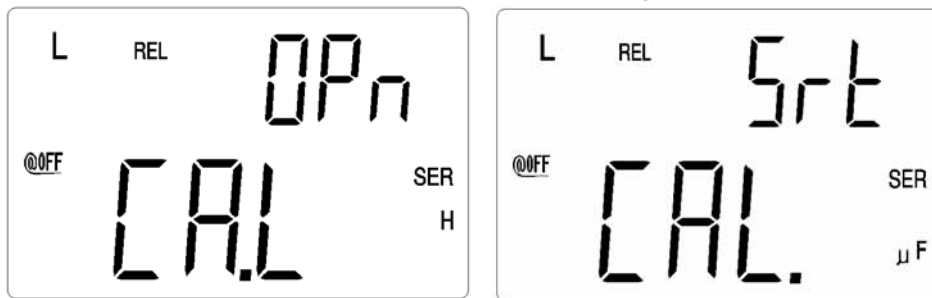

Figure-7. Open/ Short Calibration

The function calibrates the meter's internal parameters as well as external connector residues for further measuring. It is highly recommended to calibrate extremely high or low ranges for L, C and R before making precision measurements. Calibration prompts will be displayed automatically every time those ranges are manually or functionally selected, (e.g. **REL**, **TOL**, **REC** etc.), and calibration is recommended. Simply follow the open connector (OPn) or short connector (Srt) instruction and then press the "CAL" button. You may skip the calibration by pressing the "D/Q" button.

Notes:

1. Changing measurement frequencies is handled the same as selecting a different hardware range, and so automatic calibration prompts will be displayed in the recommended ranges.
2. Be sure to use same testing position after short calibration.

□ Auto Power Off/ Disable Auto Power Off

When the meter has not been used for five minutes after the last operation was made, a long "beep" tone will sound. The meter will then automatically enter a "sleep" mode and there will be no display on the LCD. To reactivate the meter, simply press any pushbutton. After re-activating.

When the meter is to be used for long period, the auto power-off can be disabled by pressing and holding "L/C/R" button while turning meter ON. Release the button, and press any button again. The  symbol will be disappeared to confirm that the auto power off has been disabled.

By using a 12V AC adaptor as an optional power source, auto power off is disabled automatically.

Note: It is recommended that the meter should always be switched off when not in use.

□ Low Battery Indication

When the " " symbol flashes on the display, the battery voltage is below normal working voltage and is weakening. Replace battery with a new one to maintain accuracy of the meter.

□ Backlit Display (Model-A only)

Press and hold " " key for more than one second to toggle backlit ON/OFF.

□ Communication

The meter is reserved with communication capability. By using an optional RS232 package, with full optical isolated cable and software. This function will assist user to record data easily.

Referring the following procedures to set up the communication between your meter and personal computer.

1. Fixes one side of cable to the meter, and the text side shall be facing up. To connect the 9-pin's terminal of cable to communication port 1 or 2 of personal computer. See the **Figure-8**.
2. Press "RS232" button to enable this interface. You will find that the symbol of "RS232" is lit on the display.
3. Execute the software to take the data for your applications.
4. Be sure to push the snap ends on the cable of meter side for removing the cable.

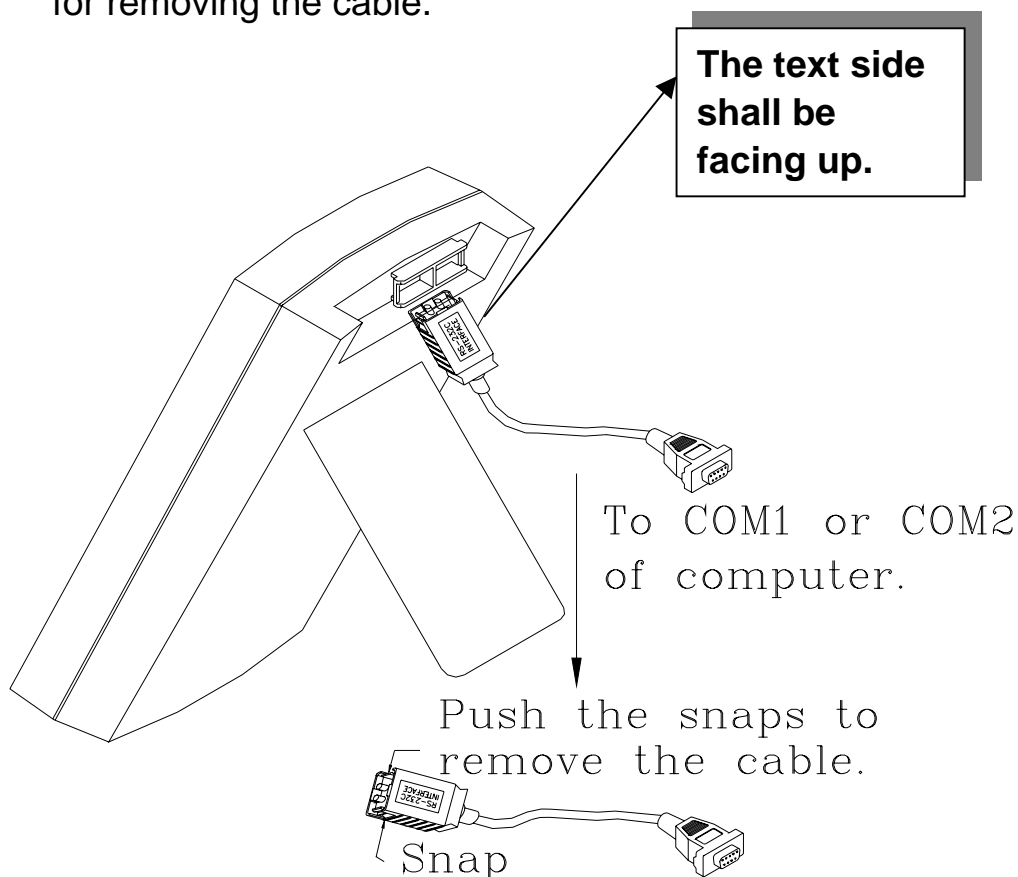

Figure-8. Cable Connection Of Communication

General Specification

Items	Model-A	Model-B
Parameters Measured	L/C/R/D/Q/	L/C/R/D/Q
Measuring Circuit Mode	Inductance (L) –Defaults to series mode Capacitance/ Resistance (C/R) -Defaults to parallel mode	
Displays	L/C/R: Maximum display 19999 D/Q: Maximum display 999 (Auto Range).	
Ranging Mode	Auto & Manual	
Measuring Terminals	3 terminals with sockets	
Test Frequency Accuracy: ±0.1 %	100Hz=100 Hz 120Hz= 120 Hz 1KHz =1010 Hz 10KHz= 9.6 KHz	120Hz= 120 Hz 1KHz =1010 Hz
Backlit display	Included	Excluded
Tolerance mode	1%, 5%, 10%, 20%	1%, 5%, 10%
Test Signal Level	0.6Vrms approx.	
Measuring Rate	1 time/second, nominal	
Response time	Approx. 1 second/ DUT (device under test)(@ manual range)	
Auto Power-Off	5 minutes approx. without operation	
Temperature Coefficient	0.15 x (Specified Accuracy) / (0-18 or 28-40)	
Operation Temperature	0 to 40 ; 0-70% R.H.	
Storage Temperature	-20 to +50 ; 0-80% R.H.	
Low Battery Indication	Approx. 6.8V	
Power Consumption	Approx. 40mA for operation/ 0.08mA after Auto Power-off.	
Power Requirements	1) DC 9V Battery 2) Ext. DC Adaptor: DC 12Vmin –15Vmax. (Load 50mA Min.)	
Protective Fuse	0.1A/250V Fuse (input protective)	
Standard Accessories	Test alligator clips (pair) DC 9V Battery. User manual	
Optional Accessories	Carrying case RS232 package SMD Tweezers DC Adaptor (EA112: AC120V) / (EA55: AC220V).	
Dimensions (L/W/H)	184/ 87/ 41 mm	
Weight	330 grams	

Electrical Specification

Accuracy is expressed as: \pm (% of reading + no. of least significant digits) at 23 \pm 5 and <75% R.H.

Model-A:

□ Resistance (Parallel mode)

Test Frequency: 100 / 120 Hz

Range	Maximum Display	Accuracy		Specified Note
		@ 100 Hz	@ 120Hz	
10M Ω	9.999M Ω	2.0%+8 *3	2.0%+8 *3	After open cal.
2000K Ω	1999.9K Ω	0.5%+5	0.5%+5	After open cal.
200K Ω	199.99K Ω	0.5%+3	0.5%+3	-
20K Ω	19.999K Ω	0.5%+3	0.5%+3	-
2000 Ω	1999.9 Ω	0.5%+3	0.5%+3	-
200 Ω	199.99 Ω	0.8%+5	0.8%+5	After short cal.
20 Ω	19.999 Ω	1.2%+40	1.2%+40	After short cal.

Test Frequency: 1K / 10K Hz

Range	Maximum Display	Accuracy		Specified Note
		@ 1K Hz	@ 10KHz	
10 M Ω	9.999M Ω	2.0%+8 * 3	3.5%+10 * 3	After open cal.
2000 K Ω	1999.9K Ω	0.5%+5	2.0%+10	After open cal.
200 K Ω	199.99K Ω	0.5%+3	1.5%+5	-
20 K Ω	19.999K Ω	0.5%+3	1.5%+5	-
2000 Ω	1999.9 Ω	0.5%+3	1.5%+5	-
200 Ω	199.99 Ω	0.8%+5	2.0%+10	After short cal.
20 Ω	19.999 Ω	1.2%+40	2.5%+200	After short cal.

Notes:

1. This specification is based on the measurement performed at the test socket.
2. DUT (Device Under Test) & Test leads be properly shielded to GUARD if necessary.
3. This specification is based on battery operation.

□ Capacitance (Parallel mode)

Test Frequency: 100 / 120 Hz

Range	Maximum Display	Accuracy		Spec. Note
		Capacitance	DF	
10mF	19.99mF *5	3.0%+5 (DF<0.1)	10%+100/Cx+5 (DF<0.1)	After short cal.
1000 μ F	1999.9 μ F*6	1.0%+5 (DF<0.1)	2%+100/Cx+5 (DF<0.1)	After short cal.
200 μ F	199.99 μ F	0.7%+3 DF<0.5	0.7%+100/Cx+5 (DF<0.5)	-
20 μ F	19.999 μ F	0.7%+3 (DF<0.5)	0.7%+100/Cx+5 (DF<0.5)	-
2000nF	1999.9nF	0.7%+3 (DF<0.5)	0.7%+100/Cx+5 (DF<0.5)	-
200nF	199.99nF	0.7%+5 (DF<0.5)	0.7%+100/Cx+5 (DF<0.5)	After open cal.
20nF	19.999nF	1.0%+5 (DF<0.1)	2%+100/Cx+5 (DF<0.1)	After open cal.

Test Frequency: 1 KHz

Range	Maximum Display	Accuracy		Spec. Note
		Capacitance	DF	
1mF	1.999mF *5	3.0%+5 (DF<0.1)	10%+100/Cx+5 (DF<0.1)	After short cal.
200 μ F	199.99 μ F	1.0%+5 (DF<0.1)	2.0%+100/Cx+5 (DF<0.1)	After short cal.
20 μ F	19.999 μ F	0.7%+3 (DF<0.5)	0.7%+100/Cx+5 (DF<0.5)	-
2000nF	1999.9nF	0.7%+3 (DF<0.5)	0.7%+100/Cx+5 (DF<0.5)	-
200nF	199.99nF	0.7%+3 (DF<0.5)	0.7%+100/Cx+5 (DF<0.5)	-
20nF	19.999nF	0.7%+5 (DF<0.5)	0.7%+100/Cx+5 (DF<0.5)	After open cal.
2000pF	1999.9pF	1.0%+5 (DF<0.1)	2.0%+100/Cx+5 (DF<0.1)	After open cal.

Test Frequency: 10 KHz

Range	Maximum Display	Accuracy		Spec. Note
		Capacitance	DF	
50 μ F	50.0 μ F	3.0%+8 (DF<0.1)	12%+100/Cx+10 (DF<0.1)	After short cal.
20 μ F	19.999 μ F	3.0%+6 (DF<0.2)	5.0%+100/Cx+8 (DF<0.2)	After short cal.
2000nF	1999.9nF	1.5%+5 (DF<0.5)	1.5%+100/Cx+6 (DF<0.5)	-
200nF	199.99nF	1.5%+5 (DF<0.5)	1.5%+100/Cx+6 (DF<0.5)	-
20nF	19.999nF	1.5%+5 (DF<0.5)	1.5%+100/Cx+6 (DF<0.5)	-
2000pF	1999.9pF	2.0%+6 (DF<0.5)	3.0%+100/Cx+6 (DF<0.5)	After open cal.
200pF	199.99pF	3.0%+8 (DF<0.1)	5.0%+100/Cx+8 (DF<0.1)	After open cal.

Notes:

1. Q Value is the reciprocal of DF.
2. This specification is based on the measurement performed at the test socket.
3. DUT & Test leads should be properly shielded to GUARD if necessary.
4. Cx=Counts of displayed C value, e.g. C=88.88 μ F then Cx=8888.
5. This reading can be extended to 1999 MAX display with accuracy not specified.
6. This reading can be extended to 19999 MAX display with accuracy not specified.

□ Inductance (Series mode)

Test Frequency: 100 / 120Hz

Range	Maximum Display	Accuracy (DF<0.5)		Spec. Note
		Inductance	DF	
1000H	999.9H	1.0%+(Lx /10000) %+5	2%+100/Lx+5	After open cal.
200H	199.99H	0.7%+(Lx /10000)%+5	1.2%+100/Lx+5	-
20H	19.999H	0.7%+(Lx /10000)%+5	1.2%+100/Lx+5	-
2000m	1999.9mH	0.7%+(Lx /10000)%+5	1.2%+100/Lx+5	-
200mH	199.99mH	1.0%+(Lx /10000)%+5	3%+100/Lx+5	After short cal.
20mH	19.999mH	2.0%+(Lx /10000)%+5	10%+100/Lx+5	After short cal.

Test Frequency: 1 KHz

Range	Maximum Display	Accuracy (DF<0.5)		Spec. Note
		Inductance	DF	
100H	99.99H	1.0%+(Lx /10000) %+5	2.0%+100/Lx+5	After open cal.
20H	19.999H	0.7%+(Lx /10000)%+5	1.2%+100/Lx+5	-
2000mH	1999.9mH	0.7%+(Lx /10000)%+5	1.2%+100/Lx+5	-
200mH	199.99mH	0.7%+(Lx /10000)%+5	1.2%+100/Lx+5	-
20mH	19.999mH	1.0%+(Lx /10000)%+5	3.0%+100/Lx+5	After short cal.
2000μH	1999.9μH	2.0%+(Lx/10000)%+5	10%+100/Lx+5	After short cal.

Test Frequency: 10 KHz

Range	Maximum Display	Accuracy (DF<0.5)		Spec. Note
		Inductance	DF	
1000mH	999.9mH	$2.0\%+(Lx/10000)\%+8$	$2.0\%+100/Lx+10$	-
200mH	199.99mH	$1.5\%+(Lx/10000)\%+8$	$2.0\%+100/Lx+10$	-
20mH	19.999mH	$1.5\%+(Lx/10000)\%+10$	$3.0\%+100/Lx+15$	-
2000 μ H	1999.9 μ H	$2.0\%+(Lx/10000)\%+10$	$8.0\%+100/Lx+20$	After short cal.

Notes:

1. Q Value is the reciprocal of DF.
2. This specification is based on the measurement performed at the test socket.
3. DUT & Test leads shall be properly shielded to GUARD if necessary.
4. Lx=counts of displayed L value, e.g. L=88.88H, then Lx=8888.

Model-B:

Resistance (parallel mode)

Test Frequency: 120Hz / 1KHz

Range	Maximum Display	Accuracy		Specified Note
		@120 Hz	@1KHz	
10M Ω	9.999M Ω	2.0%+8 *3	2.0%+8 *3	After open cal.
2000K Ω	1999.9K Ω	0.5%+5	0.5%+5	After open cal.
200K Ω	199.99K Ω	0.5%+3	0.5%+3	-
20K Ω	19.999K Ω	0.5%+3	0.5%+3	-
2000 Ω	1999.9 Ω	0.5%+3	0.5%+3	-
200 Ω	199.99 Ω	0.8%+5	0.8%+5	After short cal.
20 Ω	19.999 Ω	1.2%+40	1.2%+40	After short cal.

Notes:

1. This specification is based on the measurement performed at the test socket.
2. DUT (Device Under Test) & Test leads be properly shielded to GUARD if necessary.
3. This specification is based on battery operation.

Capacitance (parallel mode)

Test Frequency: 120 Hz

Range	Maximum Display	Accuracy		Spec. Note
		Capacitance	DF	
10mF	19.99mF *5	3.0%+5 (DF<0.1)	10%+100/Cx+5 (DF<0.1)	After short cal.
1000 μ F	1999.9 μ F*6	1.0%+5 (DF<0.1)	2%+100/Cx+5 (DF<0.1)	After short cal.
200 μ F	199.99 μ F	0.7%+3 DF<0.5	0.7%+100/Cx+5 (DF<0.5)	-
20 μ F	19.999 μ F	0.7%+3 (DF<0.5)	0.7%+100/Cx+5 (DF<0.5)	-
2000nF	1999.9nF	0.7%+3 (DF<0.5)	0.7%+100/Cx+5 (DF<0.5)	-
200nF	199.99nF	0.7%+5 (DF<0.5)	0.7%+100/Cx+5 (DF<0.5)	After open cal.
20nF	19.999nF	1.0%+5 (DF<0.1)	2%+100/Cx+5 (DF<0.1)	After open cal.

Test Frequency: 1 KHz

Range	Maximum Display	Accuracy		Spec. Note
		Capacitance	DF	
1mF	1.999mF *5	3.0%+5 (DF<0.1)	10%+100/Cx+5 (DF<0.1)	After short cal.
200 μ F	199.99 μ F	1.0%+5 (DF<0.1)	2.0%+100/Cx+5 (DF<0.1)	After short cal.
20 μ F	19.999 μ F	0.7%+3 (DF<0.5)	0.7%+100/Cx+5 (DF<0.5)	-
2000nF	1999.9nF	0.7%+3 (DF<0.5)	0.7%+100/Cx+5 (DF<0.5)	-
200nF	199.99nF	0.7%+3 (DF<0.5)	0.7%+100/Cx+5 (DF<0.5)	-
20nF	19.999nF	0.7%+5 (DF<0.5)	0.7%+100/Cx+5 (DF<0.5)	After open cal.
2000pF	1999.9pF	1.0%+5 (DF<0.1)	2.0%+100/Cx+5 (DF<0.1)	After open cal.

Notes:

1. Q Value is the reciprocal of DF.
2. This specification is based on the measurement performed at the test socket.
3. DUT & Test leads should be properly shielded to GUARD if necessary.
4. Cx=Counts of displayed C value, e.g. C=88.88 μ F then Cx=8888.
5. This reading can be extended to 1999 MAX display with accuracy not specified.
6. This reading can be extended to 19999 MAX display with accuracy not specified.

□ Inductance (Series mode)

Test Frequency: 120Hz

Range	Maximum Display	Accuracy (DF<0.5)		Spec. Note
		Inductance	DF	
1000H	999.9H	1.0%+(Lx /10000) %+5	2%+100/Lx+5	After open cal.
200H	199.99H	0.7%+(Lx /10000)%+5	1.2%+100/Lx+5	-
20H	19.999H	0.7%+(Lx /10000)%+5	1.2%+100/Lx+5	-
2000m	1999.9mH	0.7%+(Lx /10000)%+5	1.2%+100/Lx+5	-
200mH	199.99mH	1.0%+(Lx /10000)%+5	3%+100/Lx+5	After short cal.
20mH	19.999mH	2.0%+(Lx /10000)%+5	10%+100/Lx+5	After short cal.

Test Frequency: 1 KHz

Range	Maximum Display	Accuracy (DF<0.5)		Spec. Note
		Inductance	DF	
100H	99.99H	1.0%+(Lx /10000) %+5	2.0%+100/Lx+5	After open cal.
20H	19.999H	0.7%+(Lx /10000)%+5	1.2%+100/Lx+5	-
2000mH	1999.9mH	0.7%+(Lx /10000)%+5	1.2%+100/Lx+5	-
200mH	199.99mH	0.7%+(Lx /10000)%+5	1.2%+100/Lx+5	-
20mH	19.999mH	1.0%+(Lx /10000)%+5	3.0%+100/Lx+5	After short cal.
2000μH	1999.9μH	2.0%+(Lx /10000)%+5	10%+100/Lx+5	After short cal.

Notes:

1. Q Value is the reciprocal of DF.
2. This specification is based on the measurement performed at the test socket.
3. DUT & Test leads shall be properly shielded to GUARD if necessary.
4. Lx=counts of displayed L value, e.g. L=88.88H, then Lx=8888.

MAINTENANCE

WARNING

To avoid electrical shock, do not perform any service unless you are qualified to do so.

SERVICE

If the instrument fails to operate, to check battery and test leads, and replaces them if necessary. If the instrument still can't work, double check operating procedure as described in this instruction manual. When servicing, use specified replacement parts only. The meter must be completely turned off while replacing either the fuse or battery.

Battery Replacement

The meter is powered a single 9V battery, with NEDA1604, JIS006P, IEC6F22 carbon-zinc or alkaline battery. Replace battery if the low battery sign () is displayed and flashing. Use the following procedures to replace the battery:

1. Loosen screws with suitable screwdriver and remove battery cover as **Figure-9**.
2. Replace the degraded battery with a new battery.

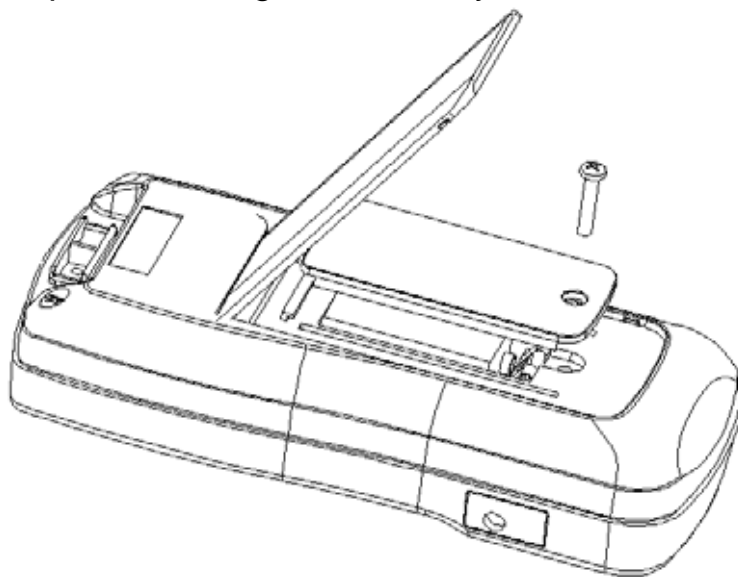

Figure-9. Battery Replacement.

□ Fuse Replacement

The meter can self-detect if its input protective fuse is either open or damaged. In this case, the LCD will display the symbol "FUSE" and an audible beep will sounds continuously, warning the user to replace the damaged fuse to maintain the accuracy of measurement. While replacing the fuse, the power of the meter must be completely shut off.

1. Loosen screws with suitable screwdriver and remove battery cover as **Figure-9**.
2. Loosen screws with suitable screwdriver and remove bottom cover as **Figure-10**.
3. Replace the damaged fuse with specified one.

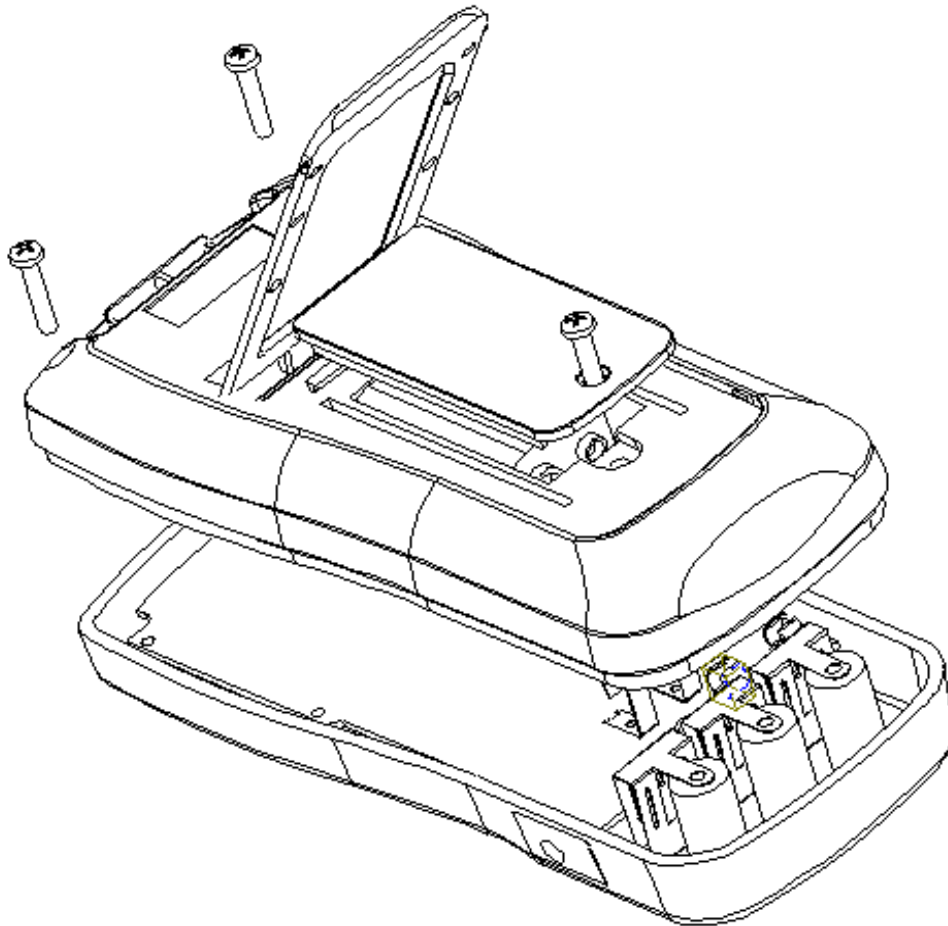

Figure-10. Fuse Replacement

□ Cleaning the Meter

WARNING

To avoid electrical shock or damaging the meter, never get water inside the case.

Before cleaning this meter, make sure the power is switched in OFF position and remove external DC adaptor. To clean the meter, wipe the dirty parts with gauze or soft cloth soaked with diluted neutral detergent. Do not get too wet to prevent the detergent from penetrating into inside parts and causing damages. After cleaning, make sure the instrument is dried completely before using.

□ Specified Accessories

Model No.	P/N	Description
	91-25178-1	User Manual
	62-25612-2U	5x20mm 0.1A/250VAC slow blow fuse
TL-23	30-25143-1/2	Test alligator clips
EC-170	29B-25208-1	Carrying case
EA-55	63-2237-803	AC220V to DC Adapter
EA-112	63-2637-806A	AC120V to DC Adapter
CP-09		Software package
TW-01		SMD Tweezers

This page subjects to be blank.

P/N: 91-25178-1

Printed in Taiwan

This page subjects to be blank.

Thank you for purchasing an ESCORT instrument.
For complete information and specifications on ESCORT
instruments, ask your distributor for an ESCORT catalog.

- Digital Multi-meters
- Digital Clamp-ON Meters
- Multi-display Multi-meters
- Digital Thermometers
- Process Calibrators
- Digital L/C/R meters
- Automotive Multi-meters
- Sweep Function Generators
- Frequency Counters
- Portable Digital Storage Oscilloscopes
- Accessories

ESCORT

F3, NO. 6, Alley 6, Lane 45, Pao-Hsin Road, Hsin Tien, Taipei, Taiwan
TEL: 886-2-2913-1325 FAX: 886-2-2918-3929