

RIGOL

User's Guide

DS1000CA Series Digital Oscilloscopes

DS1302CA, DS1202CA, DS1102CA, DS1062CA

Dec. 2009

RIGOL Technologies, Inc.

Copyright

© 2009 RIGOL Technologies, Inc. All Rights Reserved.

Trademark Information

RIGOL is registered trademark of **RIGOL** Technologies, Inc.

Notices

- **RIGOL** products are protected by patent law in and outside of P.R.C..
- **RIGOL** Technologies, Inc. reserves the right to modify or change parts of or all the specifications and pricing policies at company's sole decision.
- Information in this publication replaces all previously corresponding material.
- **RIGOL** shall not be liable for losses caused by either incidental or consequential in connection with the furnishing, use or performance of this manual as well as any information contained.
- Any part of this document is forbidden to copy or photocopy or rearrange without prior written approval of **RIGOL**.

Product Certification

RIGOL guarantees this product conforms to the standards of national and industrial. Meanwhile, the related standards conform to other ISO will get further. At present, DS1000CA has passed CE, cTUVus and GOST certification.

Safety Notices

Review the following safety precautions carefully before operating the instrument to avoid any personal injuries or damages to the instrument and any products connected to it. To avoid potential hazards use the instrument as specified by this user's guide only.

The instrument should be serviced by qualified personnel only.

To Avoid Fire or Personal Injury.

Use Proper Power Cord.

Use the power cord designed for the instrument and authorized in your country only.

Ground The Instrument.

The oscilloscope is grounded through the grounding conductor of the power cord. To avoid electric shock the instrument grounding conductor(s) must be grounded properly, before making connections to the input or output terminals of the instrument.

Connect The Probe.

The probes' ground terminals are at the same voltage level of the instrument ground. Do not connect the ground terminals to a high voltage.

Observe All Terminal Ratings.

To avoid fire or shock hazard, observe all ratings and marks on the instrument. Follow the user's guide for further ratings information before making connections to the instrument.

Do Not Operate Without Covers.

Do not operate the instrument with covers or panels removed.

Use Proper Fuse.

Use the fuse of the type, voltage and current ratings as specified for the instrument.

Avoid Circuit or Wire Exposure.

Do not touch exposed connections and components when power is on.

Do Not Operate With Suspected Failures.

If suspected damage occurs with the instrument, have it inspected by qualified service personnel before further operations.

Provide Proper Ventilation.

Refer to the installation instructions for proper ventilation of the instrument.

Do Not Operate in Wet Conditions

In order to avoid short circuiting to the

interior of the device or electric shock, please do not operate in a humid environment.

Do Not Operate in an Explosive Atmosphere

In order to avoid damages to the device or personal injuries, it is important to operate the device away from an explosive atmosphere.

Keep Product Surfaces Clean and Dry

To avoid the influence of dust and/or moisture in air, please keep the surface of device clean and dry.

The disturbance test of all the models meet the limit values of A in the standard of EN 61326: 1997+A1+A2+A3, but can't meet the limit values of B.

Measurement Category

The DS1000CA series Digital Oscilloscope is intended to be used for measurements in Measurement Category I.

Measurement Category

Definitions

Measurement Category I is for measurements performed on circuits not directly connected to MAINS. Examples are measurements on circuits not derived from MAINS, and specially protected (internal) MAINS derived circuits. In the latter case, transient stresses are variable; for that reason, the transient withstand capability of the equipment is made known to the user.

WARNING

IEC Measurement Category I. The input terminals may be connected to circuit terminal in IEC Category I installations for voltages up to 300 VAC. To avoid the danger of electric shock, do not connect the inputs to circuit's voltages above 300 VAC.

Transient overvoltage is also present on circuits that are isolated from mains. The DS1000CA series Digital Oscilloscopes is designed to safely withstand occasional transient overvoltage up to 500 Vpk. Do not use this equipment to measure circuits where transient overvoltage could exceed this level.

Safety Terms and Symbols

Terms in this Manual. These terms may appear in this manual:



WARNING

Warning statements indicate the conditions or practices that could result in injury or loss of life.



CAUTION

Caution statements indicate the conditions or practices that could result in damage to this product or other property.

Terms on the Product. These terms may appear on the product:

DANGER indicates an injury or hazard that may immediately happen.

WARNING indicates a potential injury or hazard that may immediately happen.

CAUTION indicates that a potential damage to the instrument or other property might occur.

Symbols on the Product. These symbols may appear on the product:



Hazardous Voltage



Refer to Instructions



Protective Earth Terminal



Chassis Ground



Test Grounding

Instrument at a Glance

Four types of DS1000CA series digital oscilloscopes will be introduced in this book: DS1062CA, DS1102CA, DS1202CA, DS1302CA

The instrument could help users to achieve high-quality measurement by excellent performance, powerful functions and easy operation.

DS1000CA is designed for 2GSa/s maximum real-time sample rate, 50GSa/s maximum equivalent sample rate, 300MHz maximum bandwidth and 20000wfms/s waveform capture, which are used to capture rapidly changing waveforms fast and accurately. Besides, abundant trigger, math and acquire functions enable it easy to capture and analyze waveforms, also, **AUTO** button is available to display a signal automatically. What's more, design of panels, LCD, interface and buttons are friendly and clear, making operation more comfortable.

Main Features:

- Dual Channel, Bandwidth:
300MHz (DS1302CA)
200MHz (DS1202CA)
100MHz (DS1102CA)
60MHz (DS1062CA)
- Color TFT LCD, 320×234 pixels resolution.
- Plug and play USB storage.
- Adjustable waveform intensity, more effective waveform viewing.
- One-touch automatic setup, ease of use (AUTO).
- Supports waveforms, setups, bitmap and CSV format storage and reappearance of waveforms and setups.
- Delayed Scan Function, easy to give attention to both details and overview of a waveform.
- 20 Automatic measurements.
- Automatic cursor tracking measurements.
- Waveform recorder, record and replay dynamic waveforms.
- User selectable fast offset calibration.
- Built-in FFT function, Frequency Counter.

RIGOL

- Digital filters, includes LPF, HPF, BPF, BRF.
- Pass/Fail Function, optically isolated Pass/Fail output.
- Add, Subtract and Multiply Mathematic Functions.
- Advanced trigger types include: Edge, Video, Pulse width, Slope, Alternative.
- Adjustable trigger sensitivity.
- Multiple Language User Interface.
- Pop-up menu makes it easy to read and easy to use.
- Built-in Chinese and English help system.
- Easy-to-use file system supports Chinese & English characters file name input.

Structure of This Document

Chapter 1 Quick Start

To introduce the panels and menus to help user to realize the base operations.

Chapter 2 Operating Your Oscilloscope

More details to help users to understand the functions and measurements of instrument deeply.

Chapter 3 Application Examples

To show the measurement functions directly by application examples.

Chapter 4 Troubleshooting

Provide you troubleshooting to solve the problems during operating.

Chapter 5 Specifications

List common specifications and characteristics of DS1000CA series oscilloscope.

Chapter 6 Appendix

Information about accessories, warranties, services and supports and the like.

Content

Safety Notices	II
Instrument at a Glance	V
Chapter 1 Quick Start	1-1
General Inspect	1-2
Panels and User Interface	1-3
Function Check.....	1-7
To Compensate Probes	1-9
To Display a Signal Automatically	1-10
To Understand the Vertical System	1-11
To Understand the Horizontal System	1-13
To Understand the Trigger System	1-15
Chapter 2 Operating Your Oscilloscope.....	2-1
To Set Up the Vertical System	2-2
Channel Settings	2-4
Math functions	2-14
REF function	2-18
To Set Up the Horizontal System	2-25
Delayed Scan.....	2-27
X-Y Format.....	2-28
To Set Up the Trigger System.....	2-29
Edge Trigger	2-30
Pulse Width Trigger	2-31
Video Trigger	2-32
Slope Trigger	2-34
Alternative Trigger.....	2-36
Trigger Settings.....	2-39
Trigger Holdoff.....	2-40
To Set Up the Sampling System.....	2-44
To Set Up the Display System.....	2-48
To Store and Recall Waveforms or Setups.....	2-51
To Set Up the Utility.....	2-58
I/O Setup	2-60
Language	2-61
Pass/Fail	2-62

Waveform Recorder	2-66
Print Set.....	2-70
Self-Calibration	2-71
Service.....	2-72
Preference.....	2-73
To Measure Automatically.....	2-75
Automatic measurement of voltage parameters.....	2-79
Automatic measurement of time parameters.....	2-80
To Measure with Cursors	2-81
Manual Mode.....	2-82
Track Mode	2-84
Auto Mode	2-86
To Use Run Control Buttons.....	2-87
Chapter 3 Application & Examples.....	3-1
Example 1: Taking Simple Measurements.....	3-1
Example 2: View a Signal Delay Caused by a Circuit.....	3-2
Example 3: Capture a Single-Shot Signal	3-3
Example 4: To Reduce the Random Noise on a Signal	3-4
Example 5: Making Cursor Measurements.....	3-6
Example 6: The application of the X-Y operation.....	3-8
Example 7: Triggering on a Video Signal	3-10
Example 8: FFT Cursor Measurement	3-12
Example 9: Pass/Fail Test.....	3-13
Chapter 4 Troubleshooting	4-1
Chapter 5 Specifications	5-1
Specifications	5-2
General Specifications.....	5-6
Chapter 6 Appendix	6-1
Appendix A: DS1000CA series Accessories.....	6-1
Appendix B: Warranty	6-2
Appendix C: Maintenance	6-3
Appendix D: Contact RIGOL.....	6-4
Index	1

Chapter 1 Quick Start

This chapter covers the following topics:

- General Inspect
- Panels and User Interface
- Function Check
- To Compensate Probes
- To Display a Signal Automatically
- To Understand the Vertical System
- To Understand the Horizontal System
- To Understand the Trigger System

General Inspect

After receiving a new DS1000CA series oscilloscope, please inspect the instrument as follows:

1. Inspect the shipping container for damage.

Keep the damaged shipping container or cushioning material until the contents of the shipment have been checked for completeness and the instrument has passed both electrical and mechanical test.

The consigner or carrier shall be liable for the damage to instrument resulting from shipment, without free maintenance or replacement by **RIGOL**.

2. Inspect the instrument.

In case of any damage, or defect, or failure, notify your **RIGOL** Sales Representative.

3. Check the accessories.

Accessories supplied with the instrument are listed in "Appendix A: DS1000CA series Accessories" in this guide.

If the contents are incomplete or damaged, please notify your **RIGOL** Sales Representative.

Panels and User Interface

The first thing to do with a new oscilloscope is to know its panels. This chapter helps to be familiar with the layout of the knobs and keys and how to use them. Read the chapter carefully before further operations.

The Front Panel

The front panel is divided into "function menu", "run control", "trigger control", "horizontal control" and "vertical control" areas.

Thereinto, five grey menu buttons which lie beside LCD screen (defined No.1 to No.5) are used to switch current menu options. Other function buttons are used to enable the access to many measurement features associated with advanced functions, mathematics, reference or to run control features. In addition, multi-function knob is available to adjust waveform brightness or switch menus, but others are applied to adjust offset, volts/div or s/div.

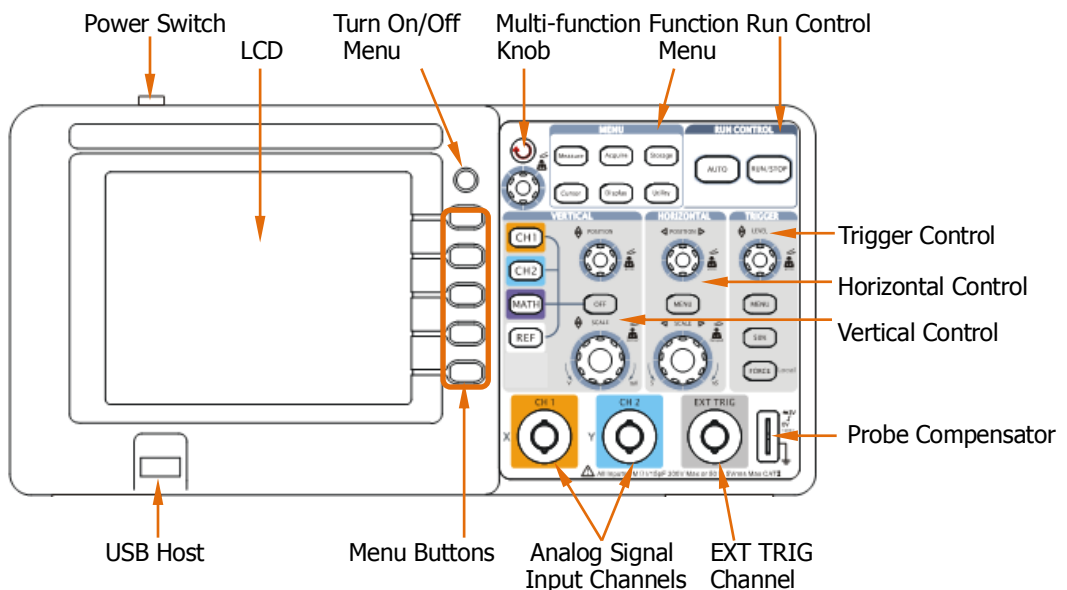

Figure 1-1
Front panel of DS1000CA series oscilloscope

Interfaces:

USB Host: It is used to connect DS1000CA with external USB devices when the oscilloscope is regarded as "Host Device". For example, connect a USB flash device.

Signal Input: Two channels are provided: CH1 and CH2.

EXT TRIG Input: It is applied to input external trigger signal.

The Rear Panel

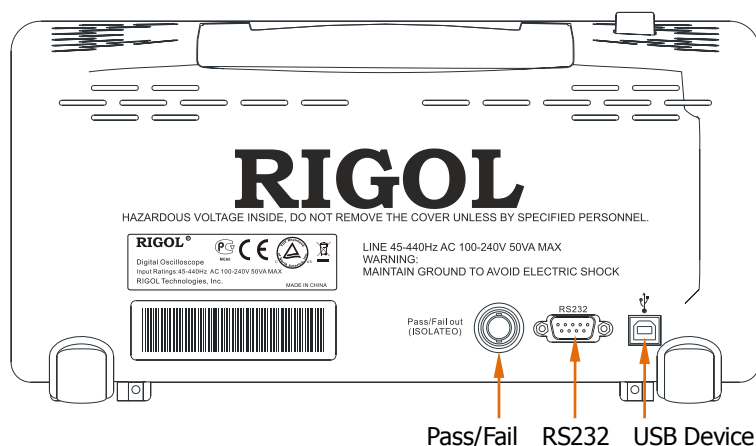

Figure 1-2
Rear panel of DS1000CA series oscilloscope

Interfaces:

Pass/Fail: It is used to output the pass/fail test result.

RS232: To connect the oscilloscope with external devices by serial port.

USB Device: It is used to connect DS1000CA with external USB devices when the oscilloscope is regarded as a "Slave Device". For example, connect with PC for remote control.

Notation definitions in this User's Guide:

Throughout this manual, notation symbols of buttons and knobs are the same of those on front-panel.

- A box around the name of the key denotes MENU function buttons on front-panel, such as Measure.
- (⤵) denotes the multi-function knob (⊙).
- ⊙POSITION denotes the two POSITION knobs.
- ⊙SCALE denotes the two SCALE knobs.
- ⊙LEVEL denotes the LEVEL knob.
- The name with a drop shadow denotes the menu operating key, such as Waveforms soft key in Storage menu.
- Use "→" to divide operation steps. Such as: Storage → Storage, indicates press "Storage" button on the front panel, then press "Storage" menu.

User's Interface

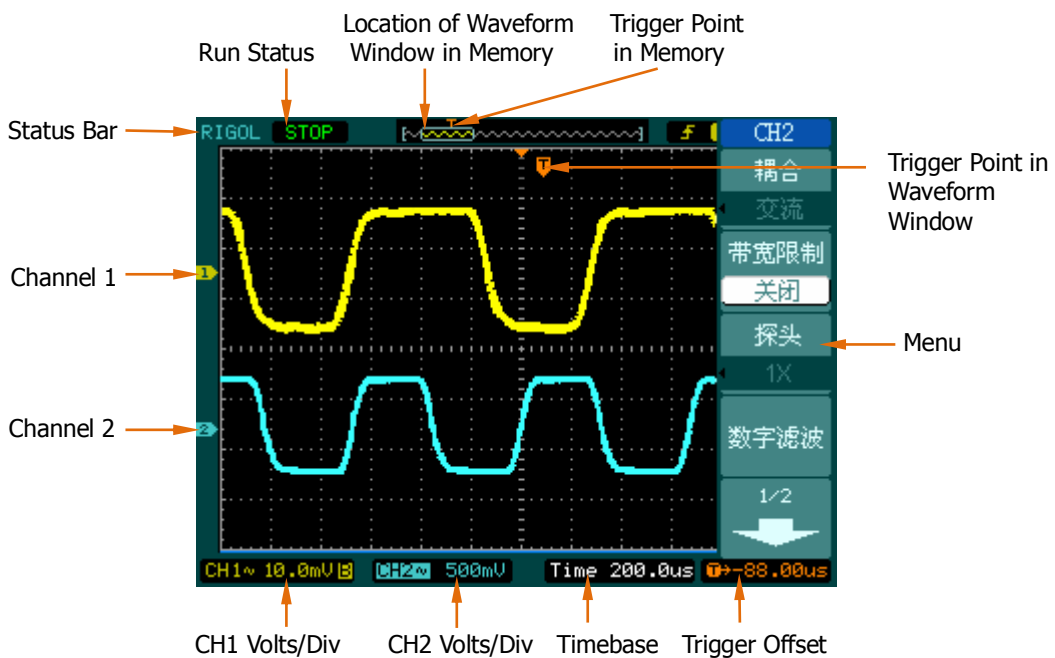

Figure 1-3 User's Interface

Function Check

Perform this quick functional check to verify that the instrument is operating correctly.

1. Turn on the instrument

Use the power cord designed for the oscilloscope to connect the instrument and AC power which delivers 100 to 240 VAC_{RMS}, 45Hz to 440Hz. Press the power switch to turn on the instruments, waiting until the display shows the waveform window.

2. Recall factory setting

Press **Storage** → **Storage** → **Factory** → **Load**, to recall factory setting.

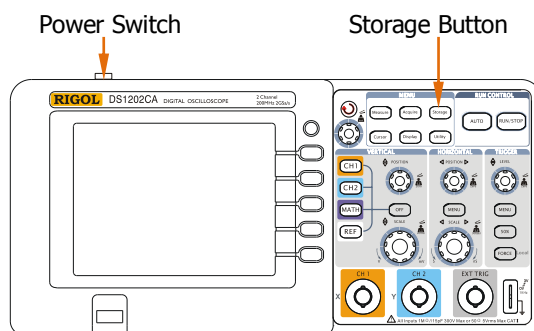

Figure 1-4
Turn on the instrument



WARNING

To avoid electric shock, be sure the oscilloscope is properly grounded.

3. Input a signal to a channel of the oscilloscope

- Push BNC plug of probe into CH1 BNC connector, then twist the BNC cable to right to lock the probe in place. Switch on the probe to 10X.

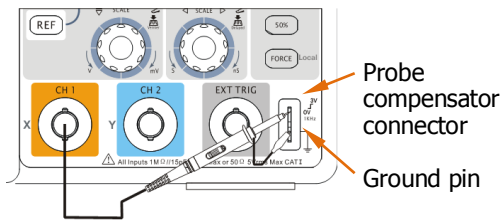

Figure 1-5 Probe connection

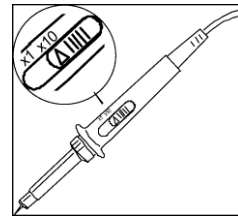

Figure 1-6 Probe adjustment

- Press **CH1** → **Probe** → **10X** to set probe attenuation of the oscilloscope, so as to make sure the measurement result is correct. (Default probe attenuation scale is 1X.)
- Attach the probe tip to the Probe compensator connector and the reference lead to the ground pin. Press **AUTO**, within a few seconds, a square wave will display (approximately 1 kHz 3 V peak- to- peak).
- Push the **OFF** button or push the **CH1** button again to turn off Channel 1. Push the **CH2** button to turn on channel 2, repeat steps above.

To Compensate Probes

Perform this adjustment to match the characteristics of the probe and the channel input. This should be performed whenever attaching a probe to any input channel the first time.

1. From CH1 menu, set the Probe attenuation to 10X (press **CH1** → **Probe** → **10X**). Set the switch to 10X on the probe and connect it to CH1 of the oscilloscope. When using the probe hook-tip, inserting the tip onto the probe firmly to ensure a proper connection.
2. Attach the probe tip to the Probe compensator connector and the reference lead to the ground pin, Select CH1, and then press **AUTO**.
3. Check the shape of the displayed waveform.

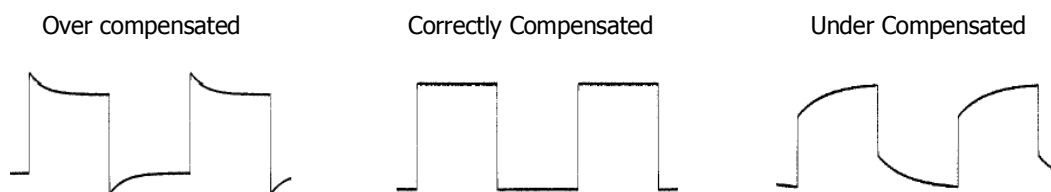

Figure 1-7 Waveform compensation

4. If necessary, use a non-metallic tool to adjust the trimmer capacitor of the probe for the flattest square wave being displayed on the oscilloscope.
5. Repeat if necessary.



WARNING

To avoid electric shock while using the probe, be sure the perfection of the insulated cable, and do not touch the metallic portions of the probe head while it is connected with a voltage source.

To Display a Signal Automatically

The oscilloscope has an automated feature to display the input signal best-fit. The input signal should be 50Hz or higher and a duty cycle is greater than 1%. Please take the following steps:

1. Connect a signal to the oscilloscope input channel.
2. Press **AUTO**.

The oscilloscope will set up VERTICAL, HORIZONTAL and TRIGGER controls automatically. You also could adjust the controls manually to get the best results if necessary.

To Understand the Vertical System

See figure 1-8 as below, the **VERTICAL Control Area** contains a series of buttons and knobs, which are not only used to set CH1, CH2, math and reference waveform functions, but also to adjust vertical position and "Volts/div".

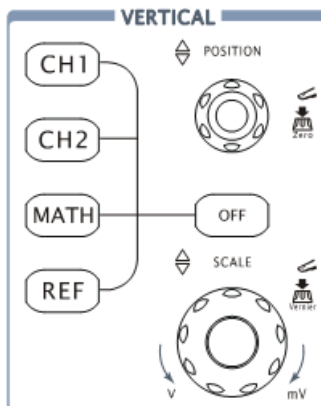

Figure 1-8 Vertical Control



1. Press **CH1**, **CH2**, **MATH**, **REF**, then the corresponding menu, sign, waveform and volts/div state will appear on the screen. To turn off channels, please press **OFF**.
2. Set vertical position of waveform display by **POSITION** knob.
Turning the **POSITION** knob, a voltage value is displayed for a short time indicating its value with respect to the ground reference located at the center of the screen. Also notice that the ground symbol on the left side of the display moves in conjunction with the **POSITION** knob.



Measurement hints

If the channel is DC coupled, measuring the DC component of the signal by simply noting its distance from the ground symbol.

If the channel is AC coupled, the DC component of the signal is blocked, allow you to use greater sensitivity to display the AC component of the signal.

Vertical offset back to 0 shortcut key

Turn the  POSITION knob to change the vertical display position of channel and press the  POSITION knob to set the vertical display position back to 0 as a shortcut key, this is especially helpful when the trace position is far out of the screen and want it to get back to the screen center immediately.

3. Set vertical "Volts/div" by  SCALE knob.
Rotate  SCALE to change "Volts/div", the change will be displayed in real time at the bottom of interface. Besides, the "Volts/div" contains two forms: "Fine" and "Coarse".

Coarse/Fine Shortcut key

The Coarse/Fine vertical control can be set by simply pressing the vertical  SCALE knob.

To Understand the Horizontal System

See figure 1-9 as below, the **HORIZONTAL Control Area** contains a button and two knobs, which are not only used to set up horizontal parameters and timebase, but also to adjust horizontal position of waveforms.

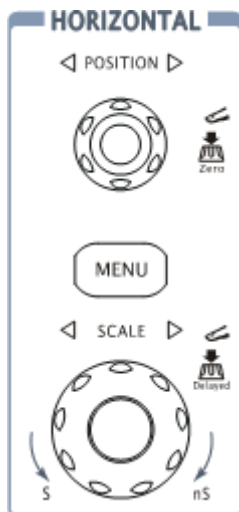

Figure 1-9 Horizontal Control

1. The horizontal **POSITION** knob adjusts signal horizontal position on waveform window.
Turning the horizontal **POSITION** knob, the waveform will move to left or right and a sign at the left-bottom of the screen will vary to show the horizontal position of the waveform.

Horizontal offset back to 0 shortcut key

Press the **POSITION** knob to set the horizontal offset to 0 as a shortcut key, this is especially helpful when the trigger point is far out of the screen and want it to get back to the screen center immediately.

2. Press **MENU** button to display "Time" menu, setting delayed state, time base mode and trigger offset.

Term Explanations

Trigger offset: Denotes the real position of the trigger point relative to the midpoint of the memory. In this setting, the trigger position will be changed horizontally when you turning the  POSITION knob.

3. Set horizontal "s/div" by  SCALE knob.

The horizontal  SCALE knob changes the sweep speed in a 1-2-5 step sequence, and displays the value in the status bar. The time base ranges of the DS1000CA series is from 2ns/div* to 50s/div.

NOTE*: The speed of horizontal scan varies by different models.

Delayed Scan Shortcut key

To press the  SCALE knob in the horizontal control area on the front-panel is another way to enter or exit Delayed Scan mode.

To Understand the Trigger System

See figure 1-10 below, the **TRIGGER Control Area** contains a knob and three buttons, which are used to set trigger level, trigger parameters and force trigger.



Figure 1-10
The trigger control window

1. Set trigger level by **LEVEL** knob.
A nacarat trigger line and trigger sign will move up and down when you turn the **LEVEL** knob, and they will disappear about 5 seconds after stop turning knob. The trigger level value will change on the screen at the same time you turn the trigger line.

Trigger Level to 0 Shortcut Key

Turn the **LEVEL** knob to change the trigger level value and press the **LEVEL** knob to set trigger level back to 0 as a shortcut key.

2. Press **MENU** button in the Trigger control. A soft button menu appears on the display showing the trigger setting choices as shown in Figure 1-11.

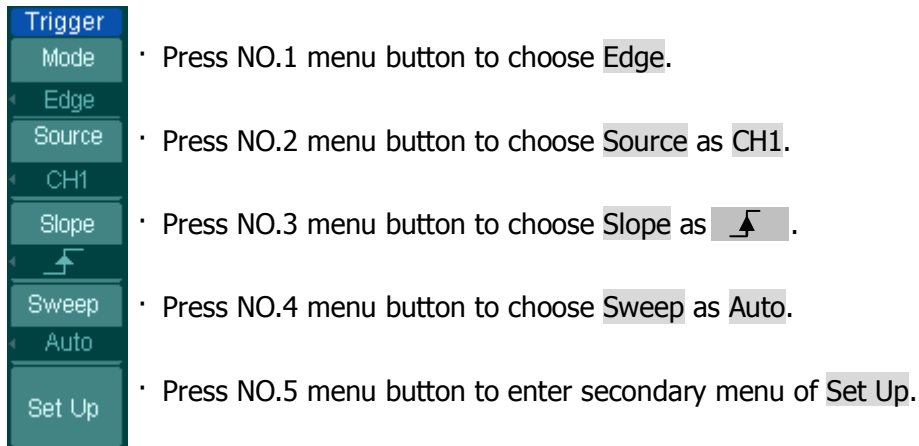

Figure 1-11

NOTE: The trigger mode, slope and source change in conjunction with the status bar on the top-right of the screen.

3. Press **50%**
The **50%** button sets the trigger level to the center of the signal.
4. Press **FORCE**
Starts an acquisition regardless of an adequate trigger signal, usually used in "Normal" or "Single" trigger mode. This button has no effect if the acquisition is already stopped.

Local/Remote control

When the instrument is in remote mode, press **FORCE** to switch to local mode.

Chapter 2 Operating Your Oscilloscope

By now, a user should understand the VERTICAL, HORIZONTAL and TRIGGER control systems and knows how to determine the system setup from the status bar of a DS1000CA-series digital oscilloscope. This chapter will go through all groups of front-panel buttons, knobs and menus; and further the knowledge of the operation by hints in this guide. It is recommended to perform all of the following exercises to get the most of the powerful measurement capabilities of the oscilloscope. If you haven't know the operations above, please refers to chapter1.

This chapter covers the following topics:

- To Set Up the Vertical System (**CH1**, **CH2**, **MATH**, **REF**, **OFF**, Vertical **POSITION**, Vertical **SCALE**)
- To Set Up the Horizontal System (**MENU**, Horizontal **POSITION**, Horizontal **SCALE**)
- To Set Up the Trigger System (**LEVEL**, **MENU**, **50%**, **FORCE**)
- To Set Up the Sampling System (**Acquire**)
- To Set Up the Display System (**Display**)
- To Store and Recall Waveforms or Setups (**Storage**)
- To Set Up the Utility (**Utility**)
- To Measure Automatically (**Measure**)
- To Measure with Cursors (**Cursor**)
- To Use Run Control Buttons (**AUTO**, **RUN/STOP**)

To Set Up the Vertical System

Two analog channels are provided by DS1000CA: CH1 and CH2. Press the corresponding button on the front panel to turn the channels on/off. The backlight indicates the channel is currently active. Press the button again to turn the channel off. When channel is currently selected, press **OFF** will turn it off and the backlight goes off.

Table 2-1 The Channels menu

Channel Mode	Settings	Status Indicator
Channel 1 (CH1)	ON	CH1 (yellow letter)
	Selected	CH1 (black letter)
	OFF	No indicator
Channel 2 (CH2)	ON	CH2 (blue letter)
	Selected	CH2 (black letter)
	OFF	No indicator
MATH	ON	MATH (purple letter)
	Selected	MATH (black letter)
	OFF	No indicator

All functions applied will base on operating the instrument with channels, so MATH and REF can be regarded as relatively isolated channels.

Knobs Explanations

Use the vertical controls to display signal waveforms by adjusting the vertical **SCALE** and **POSITION**, and setting the input parameters.

1. Using vertical **POSITION** knob

The vertical **POSITION** control changes the vertical position of signal waveforms in all channels (including MATH and REF). The resolution changes according to the vertical level set. Pressing this knob will clear the channel offset to zero.

2. Using vertical **SCALE** knob

The vertical **SCALE** control changes the vertical sensitivity of signal waveforms in all channels (including MATH and REF). If the Volts/Div is set to "Coarse", the waveform scales in a 1-2-5 step sequence from 2 mV to 10 V. If the Volts/Div is set to "Fine", it scales to small steps between the coarse settings.

3. Channels would be adjustable by the vertical **POSITION** and **SCALE** only when they are selected.

4. During the vertical positioning, a position message is displayed on the left bottom of the screen, in the same color as the corresponding channel. The unit is V (Volts). For instance: **POS: 32.4mV** Colours of words and channel waveform are the same, the unit is V.

Channel Settings

Each channel of DS1000CA has an operation menu and it will pop up after pressing **CH1** or **CH2** button. Take CH1 as an example, the settings of all items in the menu are shown in the table below.

Figure 2-1 Table 2-2 The Channel menu (Page 1/2)



Menu	Settings	Comments
Coupling	AC	Block the DC component of the input Signal.
	DC	Pass both AC and DC components of the input signal
	GND	Disconnect the input signal.
BW Limit	ON	Limit the channel bandwidth to 20MHz to reduce display noise.
	OFF	Get full bandwidth.
Probe	1X	Set this to match the probe attenuation factor to make the vertical scale readout correct.
	5X	
	10X	
	50X	
	100X	
	1000X	
Digital filter		Setup digital filter (See table 2-5).
	1/2	Go to the next menu page (The followings are the same, no more explanation).

Figure 2-2



Table 2-3 The Channel menu (Page 2/2)

Menu	Settings	Comments
	2/2	Back to the previous menu page (The followings are the same, no more explanation).
Volts/Div	Coarse Fine	Define a 1-2-5 sequence. To change the resolution to small steps between the coarse settings.
Invert	ON OFF	Turn on the invert function. Restore to original display of the waveform.
Unit	V/ A/ W/ U	Set "V", "A", "W" or "U" as the unit of vertical channel.
Input	50Ω* 1MΩ	Press this key to select the input resistance to 50Ω or 1MΩ.

NOTE*: This parameter is for DS1202CA and DS1302CA only.

1. Channel coupling

To use CH 1 as an example, input a sine wave signal with DC shift.

Press **[CH1]**→**Coupling**→**AC** to set "AC" coupling. It will pass AC component blocks the DC component of the input signal.

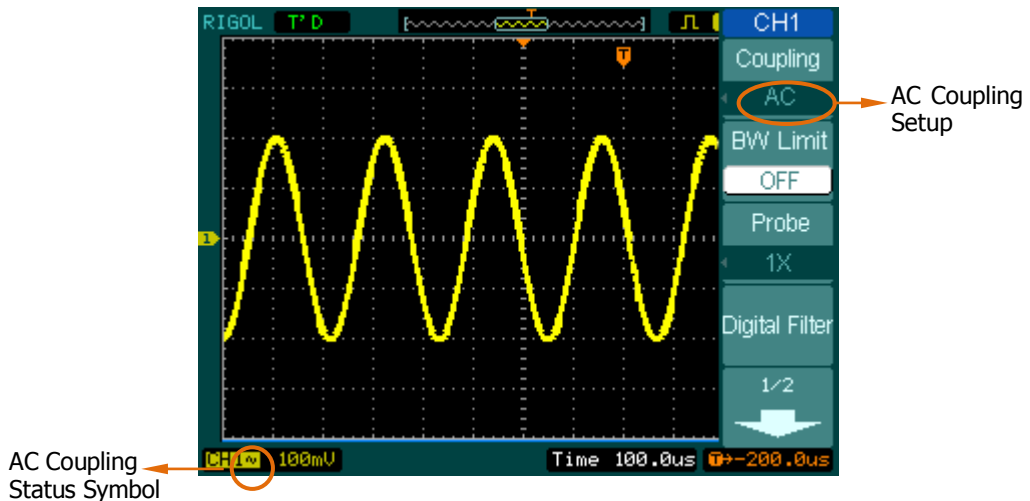

Figure 2-3 AC coupling setting

Press **[CH1]**→**Coupling**→**DC**, to set "DC" coupling. It will pass both AC and DC components of the input signal.

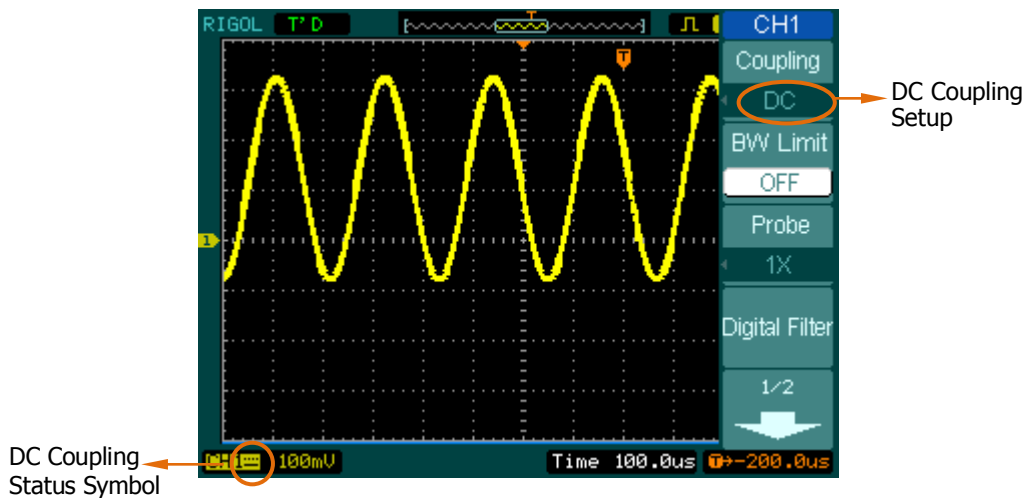

Figure 2-4 DC coupling setting

Press **CH1** → **Coupling** → **GND**, to set "GND" coupling, it disconnects the input signal.

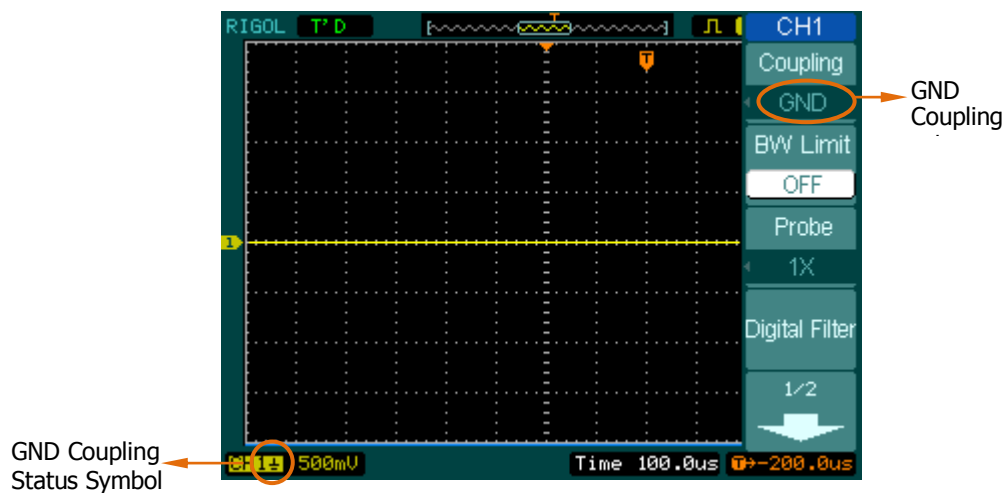

Figure 2-5 GND coupling setting

2. Set up the channel bandwidth limit

Take CH1 for an example, input a signal containing high frequency component.

Press **CH1** → **BW Limit** → **OFF**, to set up bandwidth limit to "OFF" status. The oscilloscope is set to full bandwidth and passing the high frequency component in the signal.

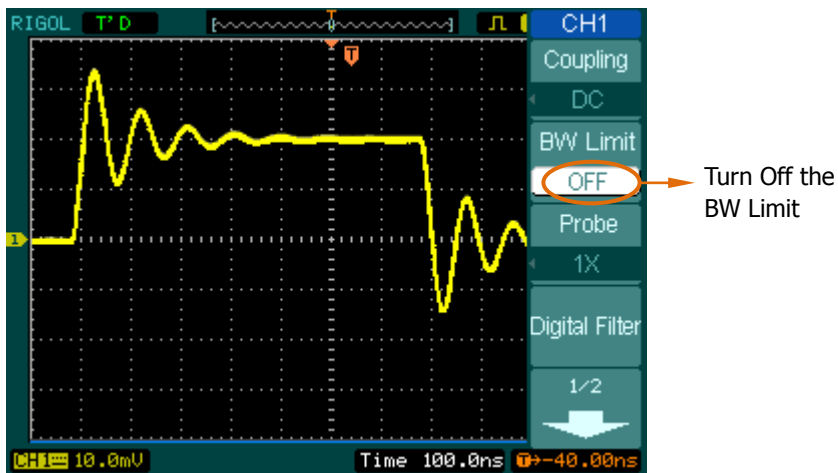

Figure 2-6 Turn off the BW limit

Press **CH1** → **BW Limit** → **ON**, to set up bandwidth limit to "ON" status. It will reject the frequency component higher than 20MHz.

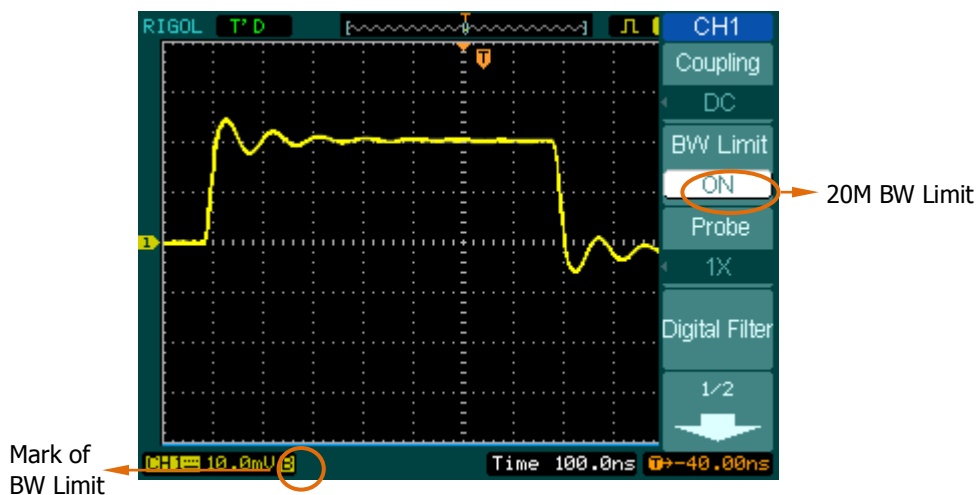

Figure 2-7 Turn on the BW limit

3. Probe Attenuation Setting

The oscilloscope allows selecting the attenuation factor for the probe. The attenuation factor changes the vertical scaling of the oscilloscope so that the measurement results reflect the actual voltage levels at the probe tip.

To change (or check) the probe attenuation setting, press the **CH1** or **CH2** button (according to which channel is using). Toggle the **Probe** soft button to match the attenuation factor of the probe.

This setting remains in effect until changed again.

Figure 2-8 shows an example for using a 1000:1 probe and its attenuation factor.

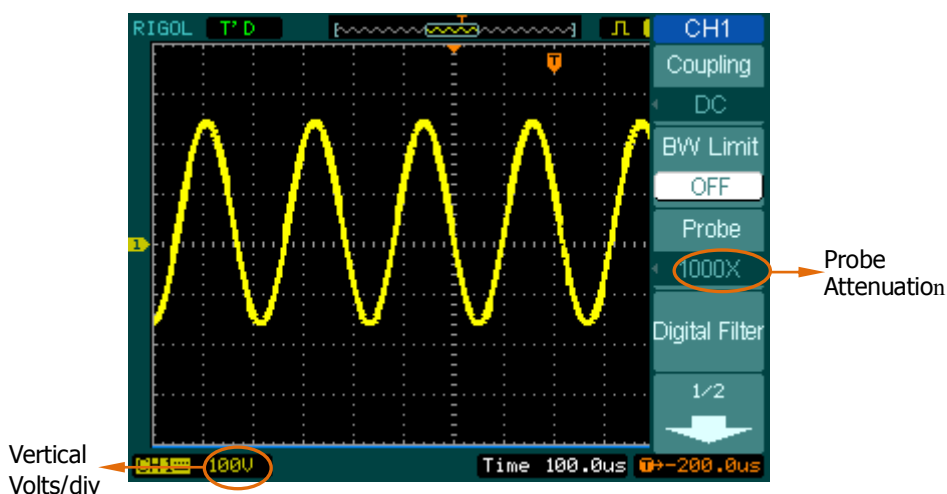

Figure 2-8 Setting probe attenuation

Table 2-4 Probe setting

Probe attenuation factors	Corresponding settings
1:1	1X
5:1	5X
10:1	10X
50:1	50X
100:1	100X
500:1	500X
1000:1	1000X

4. Digital Filter

Press **CH1** → Digital filter, display the digital filter menu.

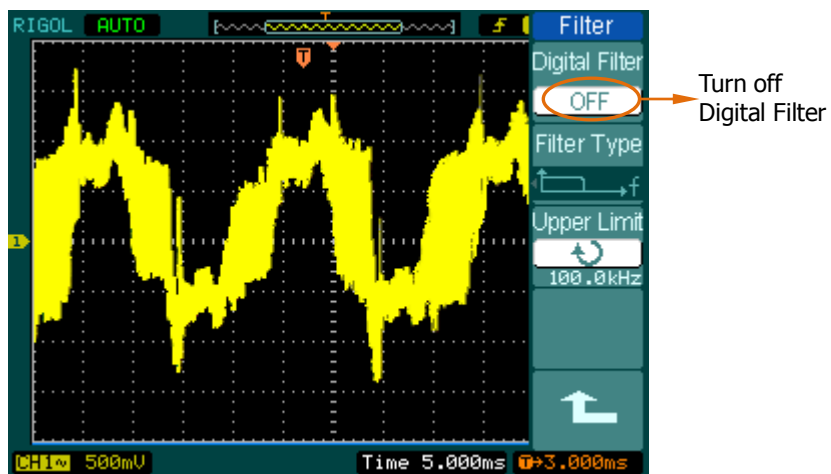
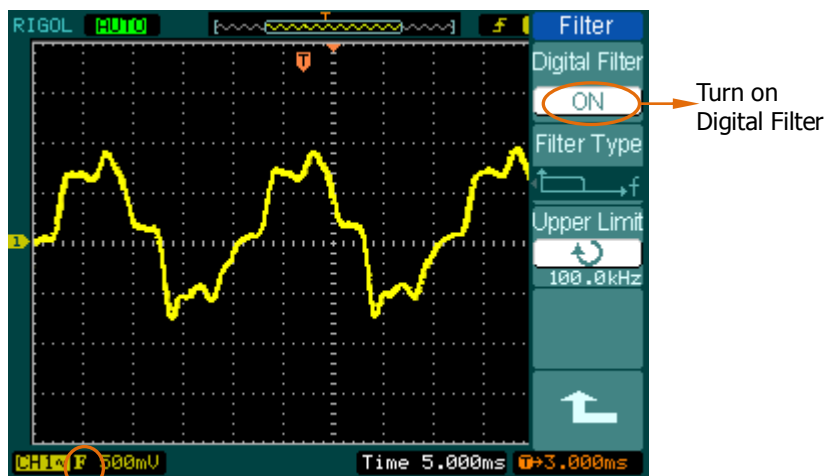

Figure 2-9 Turn off digital filter





Mark of Digital Filter

Figure 2-10 Turn on digital filter

Turn (↻) knob to set high and low limit of frequency.

Figure 2-11 Table 2-5 The Filter menu

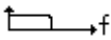
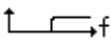
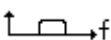
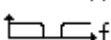

Menu	Settings	Comments
Digital Filter	Off On	Turn off the digital filter. Turn on the digital filter.
Filter Type	 f  f  f  f	Setup as LPF (Low Pass Filter). Setup as HPF (High Pass Filter). Setup as BPF (Band Pass Filter). Setup as BRF (Band Reject Filter).
Upper limit	↻ <frequency>	Turn (↻) knob to set high limit.
Lower limit	↻ <frequency>	Turn (↻) knob to set low limit.
		Back to higher level menu (The followings are the same, no more explanation).

5. Volts/Div settings

The **Volts/Div** control has **Coarse** or **Fine** configuration. The Vertical Sensitivity is 1mV/div ~10V/div.

Coarse: It is the default setting of Volts/Div in a 1-2-5-step sequence from 1mV/div, 2mV/div, 5mV/div, 10mV/div to 10 V/div.

Fine: This setting changes the vertical scale to small steps between the coarse settings. It will be helpful to adjust the waveform in smooth steps.

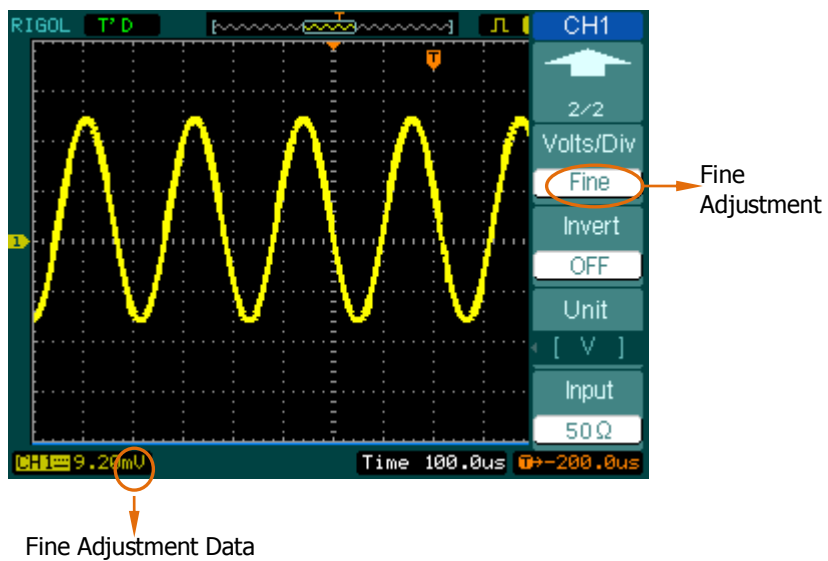



Figure 2-12 Fine configurations

Coarse/Fine Shortcut key

To change Coarse/Fine setting, not only by menu but also by pressing vertical  SCALE knob.

6. To invert a waveform

Invert turns the displayed waveform 180 degrees, as respect to the ground level. When the oscilloscope is triggered on the inverted signal, the trigger is also inverted. Figure 2-13 and 2-14 show the changes before after the inversion respectively.

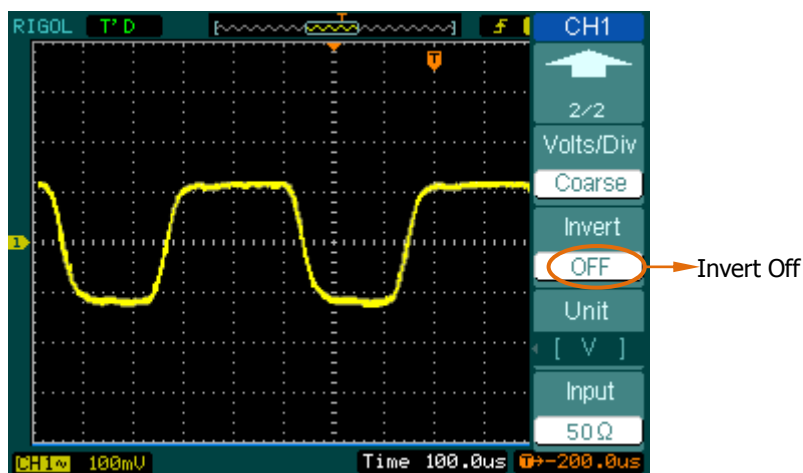

Figure 2-13
The waveform before inversion

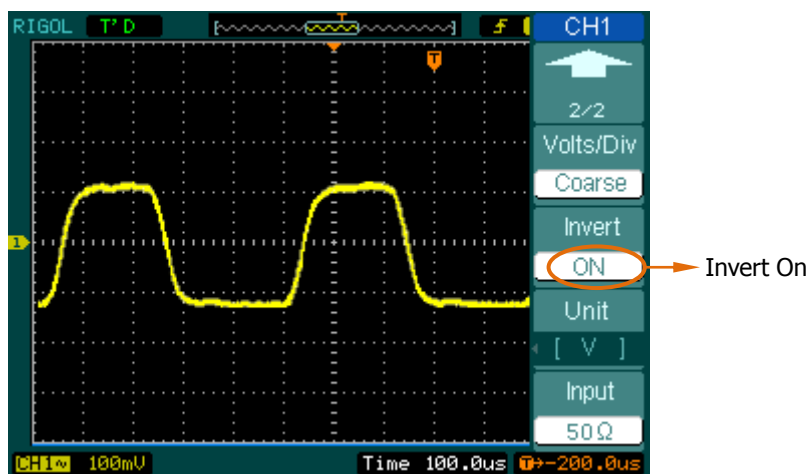

Figure 2-14
The waveform after inversion

Math functions

The mathematic functions include “Add”, “Subtract”, “Multiply” and “FFT” for Channel 1 and Channel 2. The mathematic result can be measured by the grid and the cursor.

Press **MATH** button to enter “Math” menu, meanwhile, sign of math scale will appear under the screen. See figure below, waveform of channel1 is marked yellow, waveform of channel2 is marked blue, and waveform of channel1 adding channel2 is marked purple.

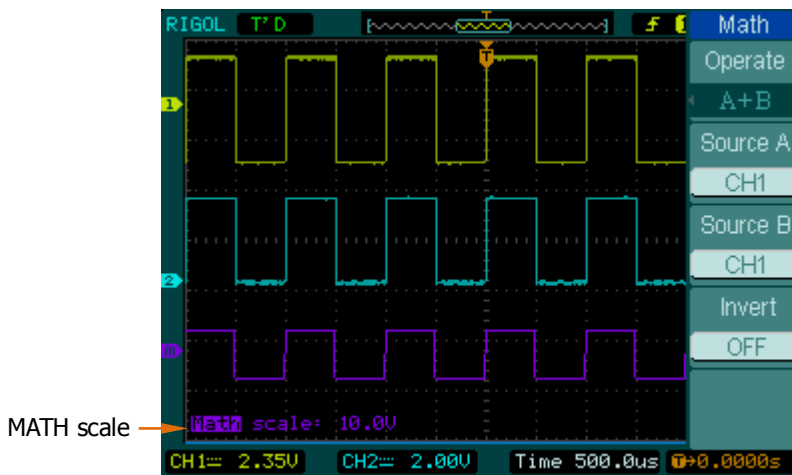

Figure 2-15 The Math function

Figure 2-16 Table 2-6 The Math menu



Menu	Settings	Comments
Operation	A+B	Add source A and source B.
	A-B	Subtract source B from source A.
	A×B	Multiply source B by source A.
	FFT	Fast Fourier Transform.
Source A	CH1 CH2	Define CH1 or CH2 as source A.
Source B	CH1 CH2	Define CH1 or CH2 as source B.
Invert	ON OFF	Invert the MATH waveform. Restore to original waveform display.

1. FFT Analyse

The FFT (Fast Fourier Transform) process converts a time-domain signal into its frequency components mathematically. FFT waveforms are useful in the following applications:

- Measuring harmonic content and distortion in systems
- Characterizing noise in DC power supplies
- Analyzing vibration

Press **MATH** → **Operate** → **FFT** to enter FFT setting menu.

Figure 2-17 Table 2-7 The FFT menu



Menu	Settings	Comments
Operate	A+B A-B A×B FFT	Add source A to source B. Subtract source B from source A. Multiply source B by source A. Fast Fourier Transform.
Source	CH1 CH2	Define CH1 or CH2 as FFT source.
Window	Rectangle Hanning Hamming Blackman	Select window for FFT.
Display	Split Full screen	Display FFT waveform on half screen. Display FFT waveform on full screen.
Scale	V_{RMS} dBV_{RMS}	Set " V_{RMS} " as vertical unit. Set " dBV_{RMS} " as vertical unit.

Key points for FFT

1. Signals that have a DC component or offset can cause incorrect FFT waveform component magnitude values. To minimize the DC component, choose **AC** Coupling on the source signal.
2. To reduce random noise and aliases components in repetitive or single-shot events, set the oscilloscope acquisition mode to **Average**.
3. To display FFT waveforms with a large dynamic range, use the dBV_{RMS} scale. The dBV_{RMS} scale displays component magnitudes using a log scale.

2. Selecting an FFT Window

Oscilloscope record the FFT change for a limit time assume that YT waveform repeat ceaselessly. If cycle is integer, YT waveform voltage is the same at starting and ending point, and waveform is consecutive. Contrary, If cycle is non-integer, the voltage is different at starting and ending point, leading to the high frequency instantaneous intermit, which is called "leak". To avoid leak, multiply a window function to force the value is 0 at starting and ending point.

DS1000CA provides four FFT functions with different feature, which are need to be selected according to measuring waveform.

Table 2-8 FFT Windows

Window	Features	Best for measuring
Rectangle	Best frequency resolution worst magnitude resolution. This is essentially the same as no window.	Transients or bursts, the signal levels before and after the event are nearly equal. Equal-amplitude sine waves with fixed frequencies. Broadband random noise with a relatively slow varying spectrum.
Hanning	Better frequency, poorer magnitude accuracy than Rectangular.	Sine, periodic, and narrow-band random noise.
Hamming	Hamming has slightly better frequency resolution than Hanning.	Transients or bursts where the signal levels before and after the events are significantly different.
Blackman	Best magnitude, worst frequency resolution.	Single frequency waveforms, to Find higher order harmonics.

Term Explanations

FFT Resolution: The quotient between sampling rate and number of FFT points. With a fixed FFT points, the lower sampling rate results in better resolution.

Nyquist Frequency

The highest frequency that any real-time digitizing oscilloscope can acquire without aliasing. It's normally half of the sample rate. This frequency is called the Nyquist frequency. Frequency above the Nyquist frequency will be under sampled, causing a situation known as aliasing.

REF function

Reference Waveforms are saved waveforms to be selected for display. The reference function will be available after saving the selected waveform to non-volatile memory.

Press **REF** button to display the Reference waveform menu.

Figure 2-18 Table 2-9 REF menu when using internal memory



Menu	Settings	Comments
Source	CH1	Select channel1 as REF channel.
	CH2	Select channel2 as REF channel.
	MATH/FFT	Select MATH/FFT as REF channel.
Location	Internal	Select memory location in scope.
	External	Select memory location out scope.
Save		Save REF waveform
Imp./Exp.		Go to import/export menu (see table 2-11).
Reset		Reset REF waveform.

Figure 2-19 Table 2-10 REF menu when using external memory



Menu	Settings	Comments
Source	CH1	Select channel1 as REF channel.
	CH2	Select channel2 as REF channel.
	MATH/FFT	Select Math/FFT as REF channel.
Location	Internal	Select memory location in scope.
	External	Select memory location out scope.
Save		Save REF waveform to outer memory location.
Import		Go to import menu (see table 2-15).
Reset		Reset REF waveform.

1. Import and Export

Switch in external memory and select **Internal** location.

Then, press **REF** → **Imp. /Exp.** and go to the following interface.

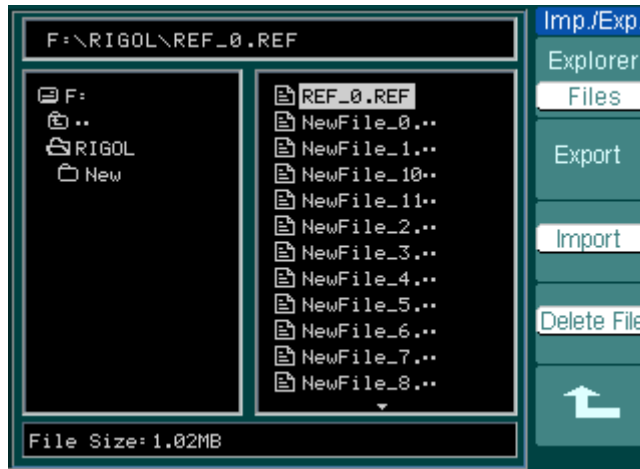

Figure 2-20 Import of export the figure

Figure 2-21 Table 2-11 The Imp. /Exp. menu



Menu	Settings	Comments
Explorer	Path Directory File	Switch to Path, directory or file.
Export		Export the REF file from internal memory to export memory (see table 2-12).
Import		Import the REF file to internal memory.
Delete File		Delete file.

2. Export

Switch in external memory and select Internal location.

Then, press **REF**→**Imp./Exp.**→**Export** and go to the following interface.



Figure 2-22 Figure export

Figure 2-23



Table 2-12 The Export menu

Menu	Settings	Comments
↑		Move the cursor up.
↓		Move the cursor down.
X		To delete chosen letter.
Save		Execute the operation.

3. Save to External memory

Switch in external memory and select External location.
 Then, press REF → Save and go to the following interface.

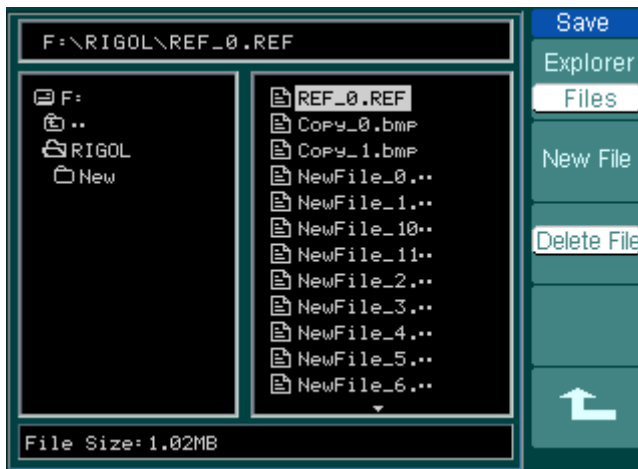

Figure 2-24 Save the figure

Figure 2-25

Table 2-13 The Save menu



Menu	Settings	Comments
Explorer	Path Directory File	Switch among Path, Directory and File.
New File (Folder)		Set up new file in Path and File. Set up new folder in directory.
Delete File (Folder)		Delete file (Folder).

4. New File (or New Folder)

Switch in external memory and select External location.

Then, press **REF**→**Save**→**New File (or New Folder)** and go to the following interface.

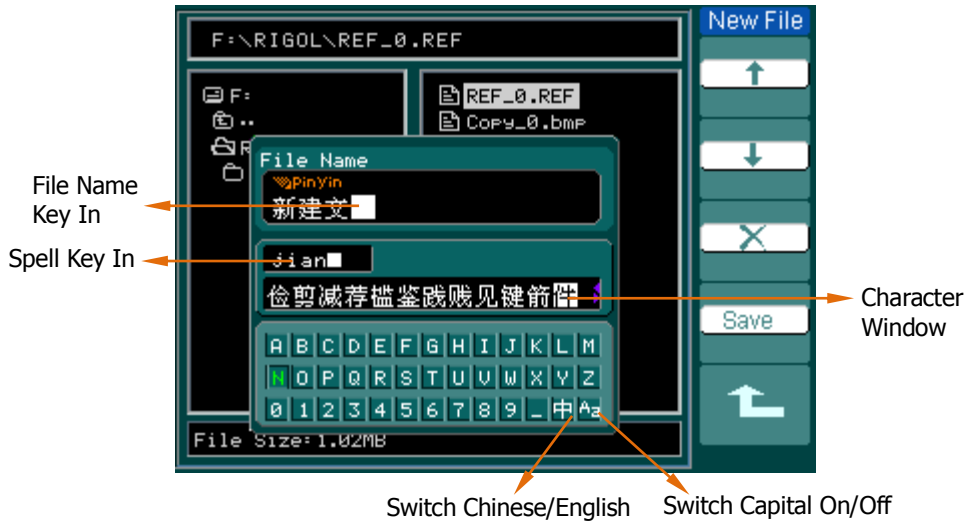

Figure 2-26 Input interface

Figure 2-27

Table 2-14 The New File menu



Menu	Settings	Comments
↑		Move the cursor up.
↓		Move the cursor down.
X		To delete chosen letter.
Save		Execute the operation.

5. Import

Switch in external memory and select **External** location.

Then, press **REF**→**Import** and go to the following interface.

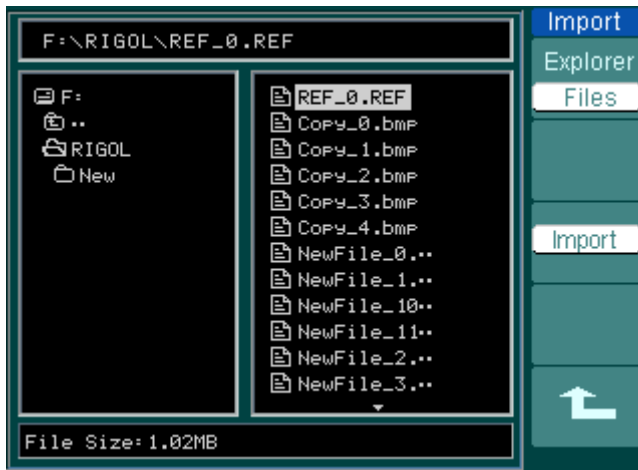

Figure 2-28 Figure import

Figure 2-29 Table 2-15 The Import menu



Menu	Settings	Comments
Explorer	Path Directory File	Switch among Path, Directory and File.
Import		Import the REF file into internal memory.

6. Display a Reference Waveform

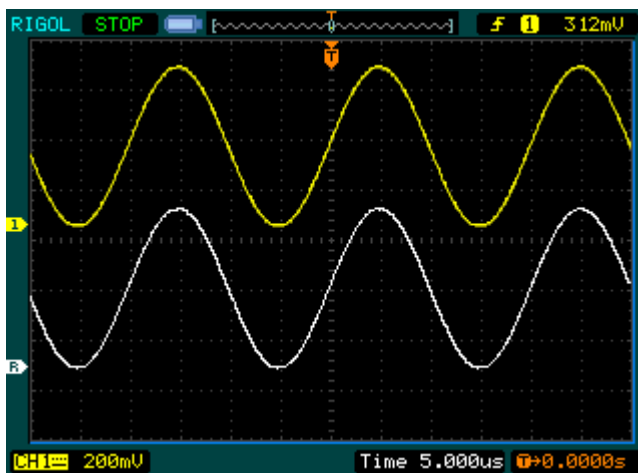

Figure 2-30 Reference waveform display

Operation Explanations:

1. Push **REF** button to show the reference waveform menu.
2. Press soft button 1 to select the reference channel: **CH1**, **CH2**, **MATH/FFT**.
3. Turn vertical **POSITION** and vertical **SCALE** to adjust the REF waveform to a suitable position.
4. Press soft button No.2 to select the save location of REF waveform.
5. Press soft button No.3 to save the waveform as REF.

NOTE: The Reference function is not available in X-Y mode.

To Set Up the Horizontal System

Press **MENU** button to enter the horizontal setting system.

Figure 2-31 Table 2-16 The Horizontal menu

Menu	Settings	Comments
Delayed	ON	Turn on Delayed Scan mode.
	OFF	Turn off the Delayed Scan mode.
Time Base	Y-T	Y-axis indicates vertical voltage, X-axis indicates horizontal time.
	X-Y	Y-axis indicates voltage of CH2, X-axis indicates voltage of CH1.
	Roll ^[1]	The waveform display updates from right to left.
Trig-offset Reset	Reset	Adjust to the center.



NOTE:



[1] No trigger or horizontal offset control of waveforms is available during Roll Mode, and it's only available when set to 500ms/div or slower.

Term Explanations:

Slow Scan Mode: This mode is available when the horizontal time base is set to 50ms or slower. In this mode, the oscilloscope acquires sufficient data for the left part to the trigger point, then wait for trigger, when trigger occurs, it continue to draw the rest part from the trigger point to the end of the right side. When choosing this mode to view low frequency signals, it is recommended that the channel coupling should be set as **DC**.

The Horizontal Knobs

The horizontal controls change the horizontal scale and position of waveforms. The horizontal center of the screen is the time reference for waveforms. Changing the horizontal scale causes the waveform to expand or contract with respect to the screen center. Horizontal position changes the displayed waveform position, relative to the trigger point.

1. Horizontal  POSITION knob is used to adjust the horizontal position of all channel (include Math) waveforms. The resolution of this control varies with the time base. Pressing this button clears trigger offset and moves the trigger point to the horizontal center of the screen.
2. Horizontal  SCALE is used to select the horizontal time/div (scale factor) for the main or the Delayed Scan time base. When Delayed Scan is enabled, it changes the width of the window zone by changing the Delayed Scan time base.

Delayed Scan

The Delayed Scan is a magnified portion of the main waveform window. Use Delayed Scan to locate and horizontally expand part of the main waveform window for a more detailed (higher horizontal resolution) analysis of signal. The Delayed Scan time base setting cannot be set slower than the Main time base setting.

Press **MENU** → **Delayed** → **ON**, or press horizontal **SCALE** knob to turn on delayed scan function. See the waveform below.

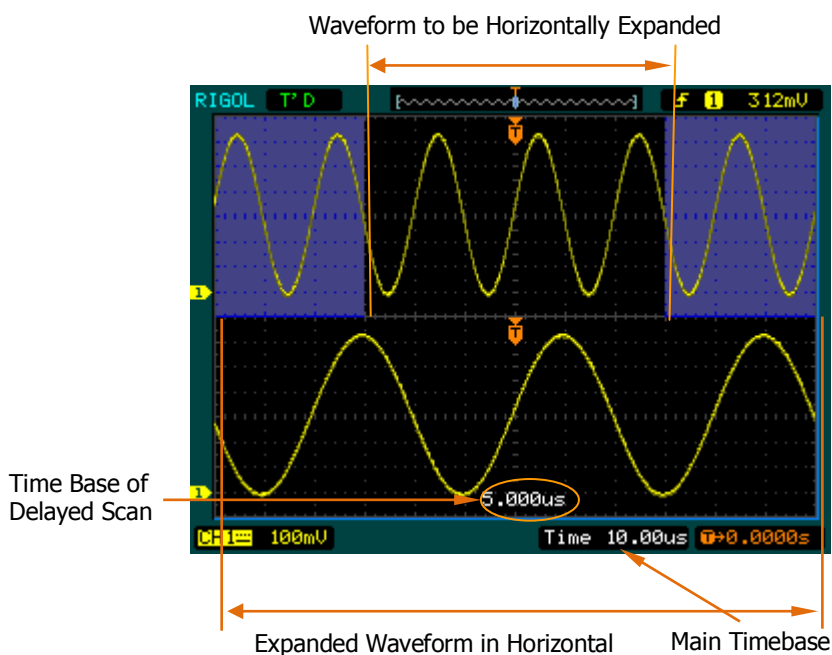

Figure 2-32 Delayed Scan windows

The screen splits into two parts as above:

The upper half displays the main waveform window and the lower half displays an expanded portion of the main waveform window. This expanded portion of the main window is called the Delayed Scan window. Two blocks shaded at the upper half; the un-shaded portion is expanded in the lower half. The horizontal **POSITION** and **SCALE** knobs control the size and position of the Delayed Scan. The value at bottom of the screen is the main time base and the value on the center bottom means the Delayed Scan time.

X-Y Format

This format is useful for studying phase relationships between two signals. CH1 in the horizontal axis(X) and CH2 in the vertical axis(Y), the oscilloscope uses a none-trigger acquisition mode, data is displayed as dots.

Press **MENU** → **Time Base** → **X-Y** to enter X-Y mode.

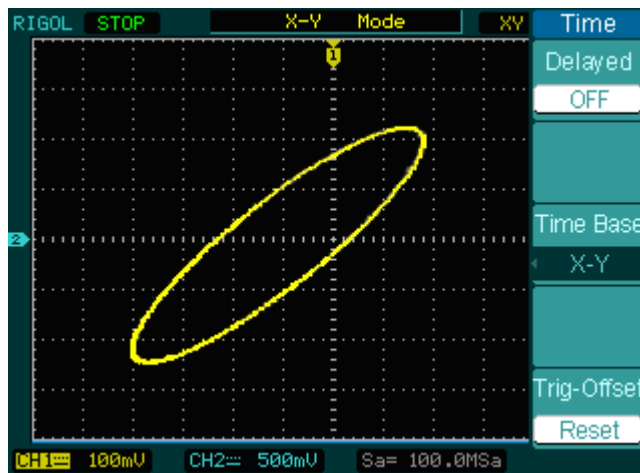



Figure 2-33 X-Y display format

The oscilloscope could capture waveform with arbitrary sample rate in Y-T mode (2GSa/s maximum for single channel, 1GSa/s maximum for double channels). While, in X-Y mode, the sample rate is up to 500MSa/s. Generally, the sample rate is more lower, the Lissajous graphics is more better.

The following modes or functions will not work in X-Y format.

- Cursor Measurements
- Pass/Fail Test
- REF or MATH Operations
- Delayed Scan Mode
- Vector Display Mode
- Horizontal  **POSITION** knob
- Trigger Controls

To Set Up the Trigger System

The trigger determines when the oscilloscope starts to acquire data and display a waveform. When a trigger is set up properly, it can convert unstable displays or blank screens into meaningful waveforms.

When the oscilloscope starts to acquire a waveform, it collects enough data so that it can draw the waveform to the left of the trigger point. The oscilloscope continues to acquire data while waiting for the trigger condition to occur. After it detects a trigger, the oscilloscope continues to acquire enough data so that it can draw the waveform to the right of the trigger point.

Press **MENU** button to enter trigger system setting interface.

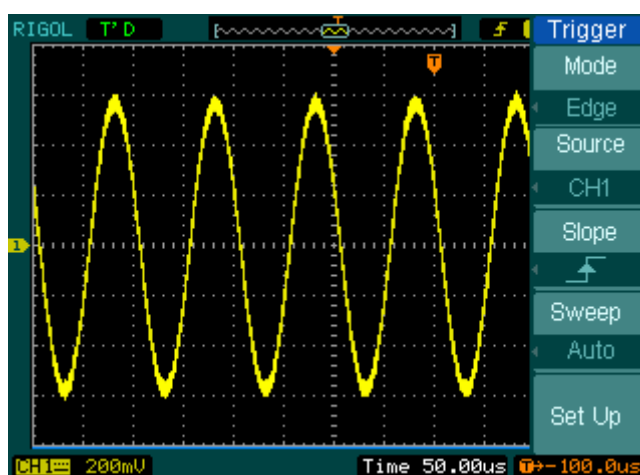

Figure 2-34 Trigger controls

DS1000CA provides five trigger modes: Edge, Pulse, Slope, Video and Alternative.

Edge: An edge trigger occurs when the trigger input passes through a specified voltage level in the specified slope direction.

Pulse: Use this trigger type to catch pulses with certain pulse width.

Video: Use video trigger on fields or lines for standard video signals.

Slope: The oscilloscope begins to trigger according to the signal rising or falling speed.

Alternative: Trigger on non-synchronized signals.

Edge Trigger

An edge trigger determines whether the oscilloscope finds the trigger point on the rising or the falling edge of a signal. Select Edge trigger Mode to trigger on Rising edge, falling edge or rising & falling edge.

Press **MENU** → **Mode** → **Edge** to enter the following menu.

Figure 2-35 Table 2-17 The Trigger menu



Menu	Settings	Comments
Source	CH1 CH2 EXT EXT/5 AC Line	Select CH1 as trigger signal. Select CH2 as trigger signal. Select EXT TRIG as trigger signal. Select attenuated EXT TRIG/5 as trigger signal. Select power line as trigger signal.
Slope	↗ ↘ ↕	Trigger on rising edge. Trigger on falling edge. Trigger on both ring & falling edge.
Sweep	Auto Normal Single	Acquire waveform even no trigger occurred. Acquire waveform when trigger occurred. When trigger occurs, acquire one waveform then stop.
Set up		To go to Set Up menu, see table 2-32

Pulse Width Trigger

Pulse trigger occurs according to the width of pulse. The abnormal signals can be detected through setting up the pulse width condition.

Press **MENU** → **Mode** → **Pulse** to enter the following menu.

Figure 2-36 Table 2-18 The Trigger menu (Page 1/2)











Menu	Settings	Comments
Source	CH1	Selects CH1 as trigger signal.
	CH2	Select CH2 as trigger signal.
	EXT	Select EXT TRIG as trigger signal.
	EXT/5	Select attenuated EXT TRIG/5 as trigger signal.
When		Set Pulse width as "+pulse width less than"
		Set Pulse width as "+pulse width more than"
		Set Pulse width as "+pulse width equal to"
		Set Pulse width as "-pulse width less than"
		Set Pulse width as "-pulse width more than"
		Set Pulse width as "-pulse width equal to"
Settings	 <Width>	Set required pulse width.

Figure 2-37 Table 2-19 The Trigger menu (Page 2/2)



Menu	Settings	Comments
Sweep	Auto	Acquire waveform even no trigger occurred.
	Normal	Acquire waveform when trigger occurred.
	Single	When trigger occurs, acquire one waveform and then stop.
Set Up		To go to Set Up menu, see table 2-32.

NOTE: The adjustable range of Pulse width is 20ns to 10s. When the condition is met, it will trigger and acquire the waveform.

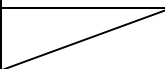
Video Trigger

Choose video trigger to trigger on fields or lines of NTSC, PAL, or SECAM standard video signals. Trigger coupling preset to DC.

Press **MENU** → **Mode** → **Video** to enter the following menu.

Figure 2-38 Table 2-20 The Video Trigger menu (Page 1/2)





Menu	Settings	Comments
Source	CH1 CH2 EXT EXT/5	Selects CH1 as trigger source. Select CH2 as trigger source. Select EXT TRIG as trigger source. Select EXT TRIG/5 as trigger source.
Polarity	 	Triggers on negative going sync pulses. Triggers on positive going sync pulses.
Sync	All Lines Line Num Odd field Even field	Trigger on all lines. Trigger on an specified line. Select to trigger on odd field. Select to trigger on even field.

Figure 2-39 Table 2-21 The Video Trigger menu (Page 2/2, when Sync is set as the specified line)



Menu	Settings	Comments
Standard	PAL/SECM NTSC	Select Video standard.
Sweep	Auto Normal Single	Force the oscilloscope to trigger in the absence of trigger condition. Lets oscilloscope to trigger in the suitable trigger condition. Lets oscilloscope to trigger one time in the suitable trigger condition, and then stop.
Set Up		To go to set up menu, see table 2-33.

Figure 2-40 Table 2-22 The Video Trigger menu (When the Sync is set as All lines, Odd field and Even field)

Menu	Settings	Comments
Standard	PAL/SECAM NTSC	Select Video standard.
Sweep	Auto Normal Single	Force the oscilloscope to trigger in the absence of trigger condition. Lets oscilloscope to trigger in the suitable trigger condition. Lets oscilloscope to trigger one time in the suitable trigger condition, then stop.
Set Up		To go to set up menu, see table 2-33.

Key points

Sync Pulses: When Normal Polarity is selected, the trigger always occurs on negative-going sync pulses. If the video signal has positive-going sync pulses, use the inverted Polarity.

Select "Line Synchronization":

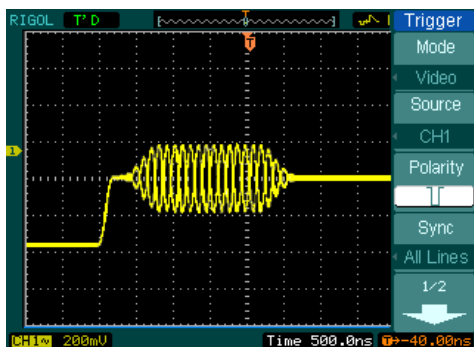

Figure 2-41

Video Trigger: Line Synchronization

Select "Filed Synchronization":

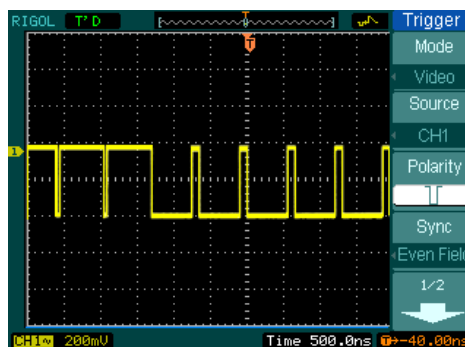

Figure 2-42

Video Trigger: Field Synchronization

Slope Trigger

Slope trigger sets the oscilloscope as the positive/negative slope trigger within the specified time.

Press **MENU** → **Mode** → **Slope** to enter the following menu.

Figure 2-43 Table 2-23 The Slope Trigger menu (Page 1/2)



Menu	Settings	Comments
Source	CH1 CH2 EXT EXT/5	Set channel 1 as trigger source. Set channel 2 as trigger source. Set EXT. channel as trigger source. Set EXT/5 as trigger source.
When		Set slope condition as "+slope more than" Set slope condition as "+slope less than" Set slope condition as "+slope equal to" Set slope condition as "-slope more than" Set slope condition as "-slope less than" Set slope condition as "-slope equal to"
Time	 <Time Set>	Set slope time.

Figure 2-44 Table 2-24 The Slope Trigger menu (Page2/2)



Menu	Settings	Comments
Vertical		Select the level that can be adjusted by LEVEL .
Sweep	Auto Normal Single	Force the oscilloscope to trigger in the absence of trigger condition. Lets oscilloscope to trigger in the suitable trigger condition. Lets oscilloscope to trigger one time in the suitable trigger condition, then stop.
Set Up		To go to set up menu. See Table 2-32.

NOTE: Slope time can be set from 20ns to 10s. When a signal meets the trigger condition, scope will execute the acquisition. You can adjust LEVEL A/ LEVEL B or both simultaneous by turning the LEVEL knob.

Alternative Trigger

When alternative trigger is on, the trigger sources come from two vertical channels. This mode can be used to observe two non-related signals. You can choose two different trigger modes for the two vertical channels. The options are as follows: Edge, Pulse, Slope and video. The info of the trigger level of the two channels will be displayed on the upper-right of the screen.

Press **MENU** → **Mode** → **Alternative** to enter the following menu.

Figure 2-45 Table 2-25 The Alternative menu (Trigger Type: Edge)



Menu	Settings	Comments
Select	CH1 CH2	Set trigger mode for Channel 1. Set trigger mode for Channel 2.
Type	Edge	Set Edge Trigger as the trigger type.
Slope		Trigger on rising edge.
		Trigger on falling edge.
		Trigger on both rising & falling edge.
Set Up		To go to set up menu. See Table 2-32.

Figure 2-46 Table 2-26 The Alternative menu (Trigger Type: Pulse Page 1/2)



Menu	Settings	Comments
Select	CH1 CH2	Set trigger mode for Channel 1. Set trigger mode for Channel 2.
Type	Pulse	Set Pulse Trigger for the channel.
When		Set Pulse width as "+pulse width less than"
		Set Pulse width as "+pulse width more than"
		Set Pulse width as "+pulse width equal to"
		Set Pulse width as "-pulse width less than"
		Set Pulse width as "-pulse width more than"
		Set Pulse width as "-pulse width equal to"

Figure 2-47



Table 2-27 The Alternative menu (Trigger Type: Pulse Page 2/2)

Menu	Settings	Comments
Setting	 <pulse width>	Set the width of the pulse.
Set Up		To go to set up menu. See Table 2-32.

Figure 2-48



Table 2-28 The Alternative menu (Trigger Type: Slope Page 1/2)

Menu	Settings	Comments
Select	CH1 CH2	Set trigger mode for Channel 1. Set trigger mode for Channel 2.
Type	Slope	Set Slope Trigger for the vertical channel.
When		Set slope condition as "+slope more than" Set slope condition as "+slope less than" Set slope condition as "+slope equal to" Set slope condition as "-slope more than" Set slope condition as "-slope less than" Set slope condition as "-slope equal to"

Figure 2-49



Table 2-29 The Alternative menu (Trigger Type: Slope Page 2/2)

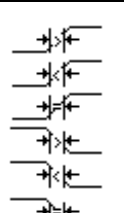

Menu	Settings	Comments
Time	 <Time Set >	Set slope time.
Vertical		Select the level to be adjusted by  LEVEL.
Set Up		To go to set up menu. See Table 2-32 and table 2-33.

Figure 2-50 Table 2-30 The Alternative menu (Trigger Type: Video Page 1/2)





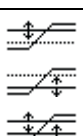

Menu	Settings	Comments
Select	CH1 CH2	Set trigger mode for Channel 1. Set trigger mode for Channel 2.
Type	Video	Video Trigger for the channel.
Polarity	 	Trigger on negative going sync pulses. Trigger on positive going sync pulses.

Figure 2-51 Table 2-31 The Alternative menu (Trigger Mode: Video Page 2/2)

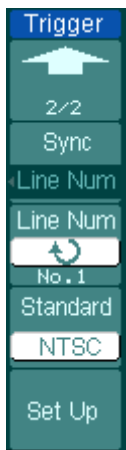

Menu	Settings	Comments
Sync	ALL lines Line Num Odd field Even field	Trigger on all lines. Trigger on an specified line. Select to trigger on odd field or even field.
Line Num	 <Lines Set >	Select the specified line number for sync.
Standard	PAL/SECM NTSC	Select Video standard.
Set Up		To go to set up menu. See Table 2-33.

Trigger Settings

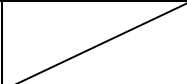
Set up different trigger settings according to different trigger modes. When in the mode of Edge and Pulse, only Holdoff is adjustable. When source is non-digital channel and in slope trigger, only trigger coupling, trigger sensitivity and Holdoff can be set. For video trigger, Sensitivity and Holdoff can be set.

Figure 2-52 Table 2-32 The Trigger Set Up menu (Settings for trigger coupling, trigger sensitivity and holdoff)



Menu	Settings	Comments
Coupling	DC AC HF Reject LF Reject	Allow all signals pass. Block DC signals. Reject high frequency signals. Reject DC and low frequency signals.
Sensitivity	 <Sensitivity Setting>	Set trigger sensitivity.
Holdoff	 <Holdoff Setting>	Set time slot before another trigger event.
Holdoff	Reset	Reset Holdoff time to 500ns.

Figure 2-53 Table 2-33 The Trigger Set Up menu (Settings for sensitivity and holdoff)



Menu	Settings	Comments
Sensitivity	 <Sensitivity Setting>	Set trigger sensitivity.
Holdoff	 <Holdoff Setting>	Set time slot before another trigger event.
Holdoff	Reset	Reset Holdoff time to 500ns.

Trigger Holdoff

Use trigger Holdoff to stabilize a complex waveform, such as a pulse range. Holdoff time is the oscilloscope's waiting period before starting a new trigger. During Holdoff, oscilloscope will not trigger until Holdoff ends. For instance: To trigger on the first pulse on a group of them, users can set the holdoff time to Pulse cluster width.

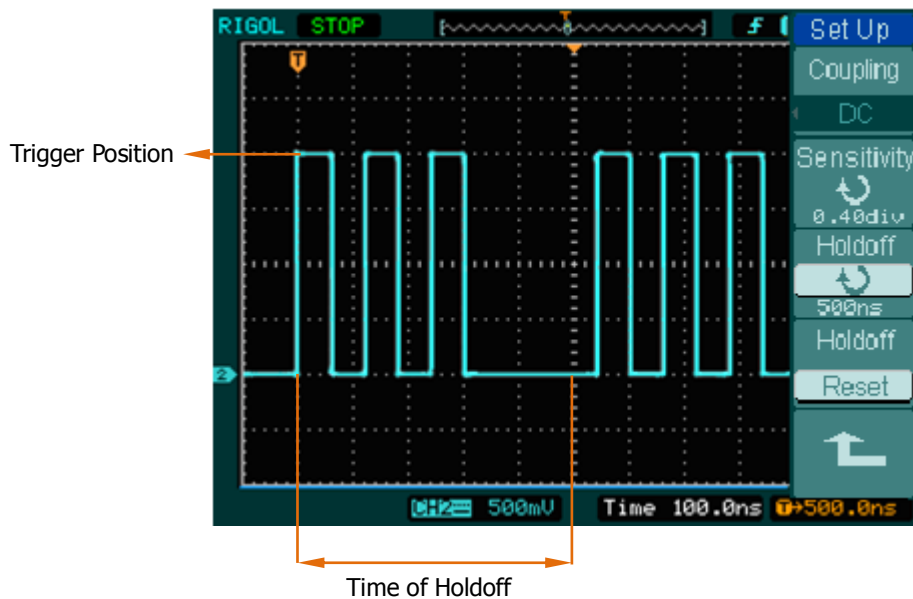

Figure 2-54 Trigger Holdoff

Operation Explanations:

- 1 Press the trigger **MENU** button to display the Menu.
- 2 Press Set Up key to display trigger set up menu.
- 3 Turn the multi function knob (↻) to change Holdoff time until waveform is stable.
- 4 Pushing Trigger **Hold off reset** to reset the Holdoff time to its default value.

Trigger Terms Explanation

1. Trigger Source:

Trigger occurs from several sources: Input channels (CH1 and CH2), AC Line, Ext, Ext/5.

- **Input Channels:**

It is the most commonly used trigger source. The channel works when selected as a trigger source whatever displayed.

- **Ext Trig:**

The instrument can be triggered from a third source while acquiring data from CH1 and CH2. For example, to trigger from an external clock or with a signal from another part of the test circuit. The Ext, Ext/5 trigger sources use an external trigger signal connected to the EXT TRIG connector. Ext uses the signal directly; it has a trigger level range of +1.6 V to -1.6 V. The EXT/5 trigger source attenuates the signal by 5X, which extends the trigger level range to +8 V to -8 V allowing the oscilloscope to trigger on a larger signal.

- **AC Line:**

AC power can be used to display signals related to the power line frequency, such as lighting equipment and power supply devices. The oscilloscope gets triggered on its AC power input, an AC trigger signal is not required.

2. Sweep Mode:

The sweep mode determines how the oscilloscope behaves in the absence of a trigger event. The oscilloscope provides three trigger modes: Auto, Normal, and Single.

- **Auto:**

This sweep mode allows the oscilloscope to acquire waveforms even when it does not detect a trigger condition. If no trigger condition occurs while the oscilloscope is waiting for a specific period (as determined by the time-base setting), it will force itself to trigger.

When forcing invalid triggers, the oscilloscope cannot synchronize the waveform, and the waveform seems to roll across the display. If valid triggers

occur, the display becomes stable on the screen.

Any factor results in the un-stability of waveforms can be detected by Auto Trigger, such as the output of Power supply.

NOTE: When horizontal control is set under 50 ms/div, Auto mode allows the oscilloscope not to capture trigger signal.

- **Normal:**

The Normal mode allows the oscilloscope to acquire a waveform only when it is triggered. If no trigger occurs, the oscilloscope keeps waiting, and the previous waveform, if any, will remain on the display.

- **Single:**

In Single mode, after pressing the RUN/STOP key, the oscilloscope waits for trigger. While the trigger occurs, the oscilloscope acquires one waveform then stop.

3. Coupling:

Trigger coupling determines which signal component passing to the trigger circuit. Coupling types include AC, DC, LF Reject and HF Reject.

- **AC:** AC coupling blocks DC components.
- **DC:** DC coupling passes both AC and DC components.
- **LF Reject:** LF Reject coupling blocks DC component, and attenuates all signal with a frequency lower than 8 kHz.
- **HF Reject:** HF Reject coupling attenuates all signals with a frequency higher than 150 kHz.

4. Pre-trigger/delayed trigger:

The data collected before and after trigger.

The trigger position is typically set at the horizontal center of the screen. In the full-screen display the 6div data of pre-trigger and delayed trigger can be surveyed. More data (14div) of pre-trigger and 1s delayed trigger can be surveyed by adjusting the horizontal  POSITION knob.

This feature is very useful to study the events that led up to the trigger point.

Everything to the right of the trigger point is called post-trigger information. The delay range (pre-trigger and post-trigger information) depends on the sweep speed selected.

5. Adjustable trigger sensitivity:

To avoid the influence of noise from the physical world, and get the stable trigger, the trigger circuit has adopted Stickiness. In DS1000CA series, the stickiness is adjustable from 0.1div-1.0div, which means when it sets to 1.0div, the trigger circuit will not affect any signal with peak-peak amplitude less than 1.0div, so as to avoid the influence of the noise.

To Set Up the Sampling System

Figure 2-55 shows the menu button for acquire system on the front panel.

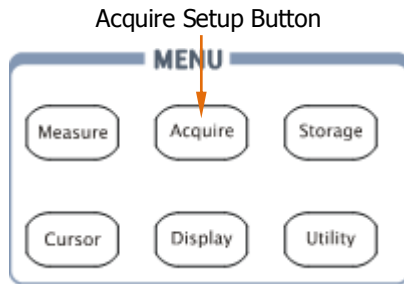

Figure 2-55 Acquire button

Press **Acquire** button, the interface menu shows as follows:

Figure 2-56 Table 2-34 The Acquire menu



Menu	Settings	Comments
Acquisition	Normal Average Peak Detect	Normal Acquisition mode. Average Acquisition mode. Peak Detect Acquisition mode.
Averages ^[1]	2 to 256	Step by 2 N times the power. Set average times from 2 to 256.
Sampling	Real-Time Equ-Time	Real-time sampling mode. Equivalent sampling mode.
Sinx/x ^[2]	ON OFF	Set the insert mode is Sinx or Line.
Sa Rate ^[3]		Display sampling rate.

NOTES:

- [1] This function appears when acquisition as "Average".
- [2] This function appears when sampling as "Real-Time".
- [3] Sample rate of CH1 and CH2 will be displayed respectively in alternative trigger mode.

The waveform displayed on the screen will change in conjunction with the setting of Acquire menu.

- To reduce the displayed random noise, select the **Average** Acquisition. This mode would make the screen refresh slower.
- To Avoid signal aliasing, select **Peak Detect** Acquisition.
- Select **Real-time** acquisition to observe the single-shot or pulse signals.
- Select **Equ-Time** to observe high frequency repetitive signals.

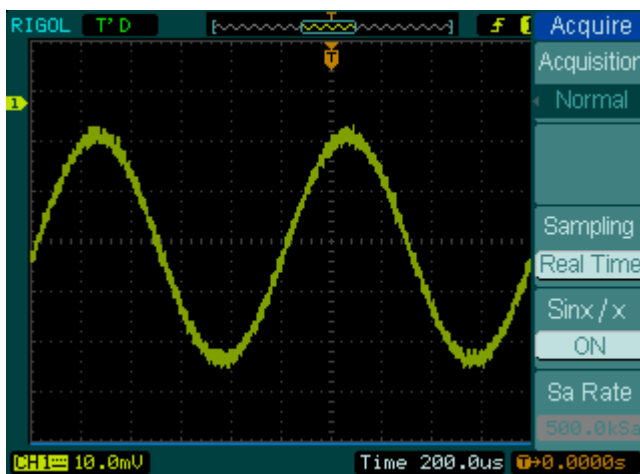

Figure 2-57

Signal that contains noise, and without average sampling

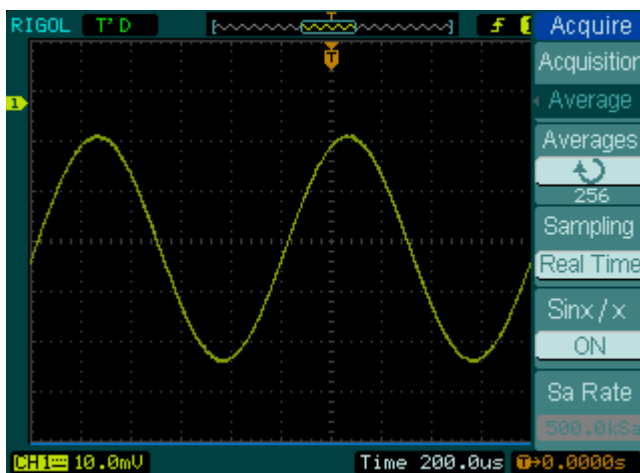

Figure 2-58

Display signal after average sampling

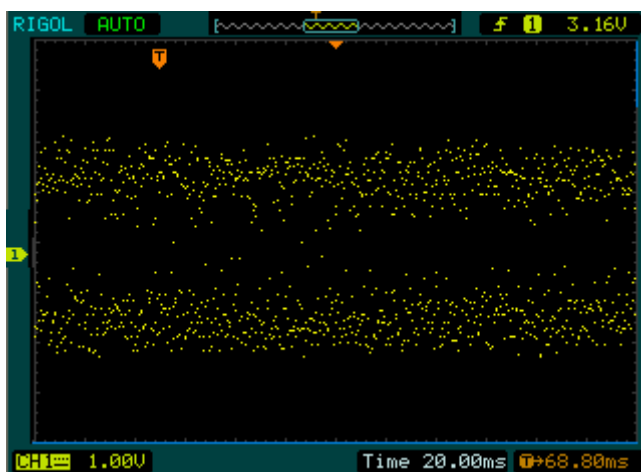

Figure 2-59
Adopt Normal acquisition

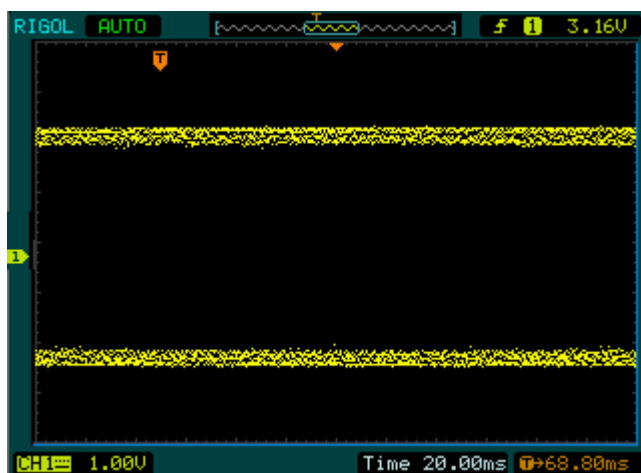

Figure 2-60
Adopt peak detect acquisition, signal contains envelope

Key points

Stop Acquisition: When the scope is acquiring waveforms, the waveforms are in a live status; when acquisition is stopped, a frozen waveform will be displayed, the position and scale can still be adjusted by vertical control and horizontal control.

Term Explanations

Real-time Sampling: DS1000CA has Real-time sampling rate up to 2GSa/s. At the time base 20ns or faster, the oscilloscopes use the sine(x)/x interpolation to expand the horizontal time base.

Equivalent sampling: Known as Repetitive sampling to get up to 20ps of horizontal resolution (equivalent 50Gsa/s). This mode is good for observing repetitive signals, and it is not recommended for single-shot or pulse.

Normal Acquisition: Oscilloscope acquires signal by equal time interval.

Average Acquisition: Apply averaging to your signal to remove uncorrelated noise and improve measurement accuracy. Reduces random or uncorrelated noise in the signal display. The averaged waveform is a running average over a specified number of acquisitions from 2 to 256.

Peak Detect: Peak Detect mode captures the maximum and minimum values of a signal. Finds highest and lowest record points over many acquisitions.

To Set Up the Display System

Figure 2-61 shows the menu button for the display system on the front panel.

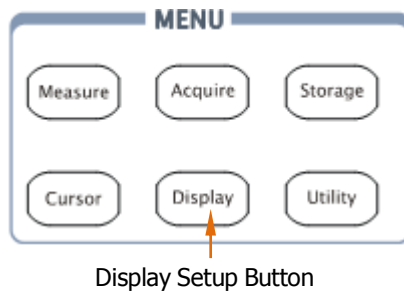

Figure 2-61 Display button

Press the **Display** button, the interface menu for settings shows as follows.

Figure 2-62 Table 2-35 The Display menu (Page 1/3)



Menu	Setting	Comments
Type	Vectors Dots	Display waveforms as vectors. Display waveforms as dots.
Clear		Clear all existing waveforms from screen.
Persist	OFF Infinite	Turn off the persistence function. The sample points remain displayed until turn the persistence "OFF".
Intensity	 <percentage>	Set up waveform intensity (0%~100%).

Key points

Display type: Display type includes Vector and Dot. In vectors type, oscilloscope connects dots through digital interpolation including both linearity and $\sin(x)/x$. $\sin(x)/x$ interpolation is suitable for Real-time sampling and will be more effective at 50ns or faster time base.

Figure 2-63 Table 2-36 The Display menu (Page 2/3)



Menu	Settings	Comments
Function	Normal	The waveform is displayed at the same intensity.
	Intensity	The intensity of waveforms is connecting to probability.
Grid		Display grids and coordinates on the screen.
		Turn off the grids.
		Turn off the grids and coordinates.
Menu Display	1s	Set the time before menu fades away. The menu will be hidden after the set time of last button pressing.
	2s	
	5s	
	10s	
	20s	
	Infinite	

Figure 2-64 Table 2-37 The Display menu (Page 3/3)

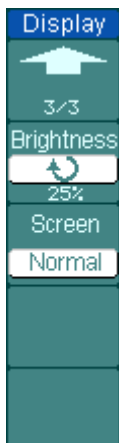

Menu	Settings	Comments
Brightness	 <percentage>	Set up grid brightness.
Screen	Normal	Set to normal mode.
	Inverted	Set to invert color display mode.

Term Explanations

Refresh rate: It is an important performance of digital oscilloscopes. It means the number of display refreshing per second and it will affect the ability to observe signal.

Adjusting waveform intensity

Default setup of multi-function knob (🔄) is adjusting waveform intensity.

To Store and Recall Waveforms or Setups

Figure 2-65 shows the menu button for the storage system on the front panel.

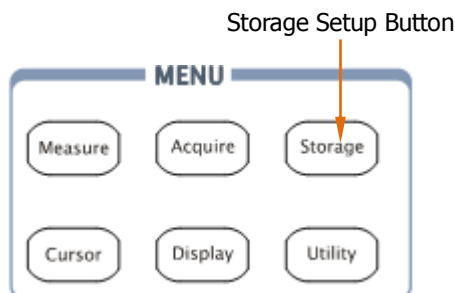

Figure 2-65 Storage button

Press the **Storage** button, the interface menu for settings shows as follows.

Figure 2-66 Table 2-38 The Storage menu (Waveform or Setups storage)



Menu	Settings	Comments
Storage ^[1]	Waveform ^[2] Setups Bit map CSV Factory	Store or recall waveform. Store or recall instrument setups. Create or delete bit map files. Create or delete CSV files. Recall factory setups.
Internal		Go to menu for internal memory operation (see Table 2-42).
External		Go to menu for external memory operation (see Table 2-43).
Disk Mana.		Go to disk manage menu (see Table 2-44).

NOTES:

[1] The waveform and setups files in internal memory can be saved, loaded and deleted. While, the waveform, setups, bit map and CSV files in external memory can be created and deleted. To restore the factory settings, please select "Factory".

[2] Both waveforms and status settings could be saved in "Waveform Storage".

Figure 2-67



Table 2-39 The Storage menu (Bit Map storage)

Menu	Settings	Comments
Storage	Bit map	Create or delete bit map files.
Para Save	On Off	Save the current oscilloscope settings in different format with the same file name.
External		Go to menu for external memory operation (see Table 2-43).
Disk Mana.		Go to disk manage menu (see Table 2-44).

Figure 2-68



Table 2-40 The Storage menu (CSV storage)

Menu	Settings	Comments
Storage	CSV	Create or delete CSV files.
Data Depth	Displayed Maximum	Save currently displayed waveform data to CSV file. Save the whole waveform data in memory to CSV file.
Para Save	On Off	Save the current oscilloscope settings in different format with the same file name.
External		Go to menu for external memory operation (see Table 2-43).
Disk Mana.		Go to disk manage menu (see Table 2-44).

Figure 2-69



Table 2-41 The Storage menu (Factory storage)

Menu	Settings	Comments
Storage	Factory	Recall factory setups.
Load		Recall factory setups or files.
Disk Mana.		Go to disk manage menu (see Table 2-44).

Internal Memory

Press **Storage** → **Internal** to go to the following menu.

Figure 2-70 Table 2-42 The Internal Memory menu



Menu	Settings	Comments
Internal	Int_00 (S) Int_01 (S) · · Int_09 (N)	Set up the location of files in internal memory among Int_00 to Int_09. Thereinto, S in brackets indicates the location has storage file, N indicates has not.
Load		Recall waveform files and setup files from the internal memory location.
Save		Save waveform files and setup files to the internal memory location.
Delete File		Delete the files

NOTE: To ensure the setups being saved properly, only after the settings are changed for more than 5 seconds can the user turn off the instrument. The oscilloscope can store 10 settings permanently and can restore at anytime.

External Memory

Switch in external memory, press **Storage** → **External** to go to the following menu.

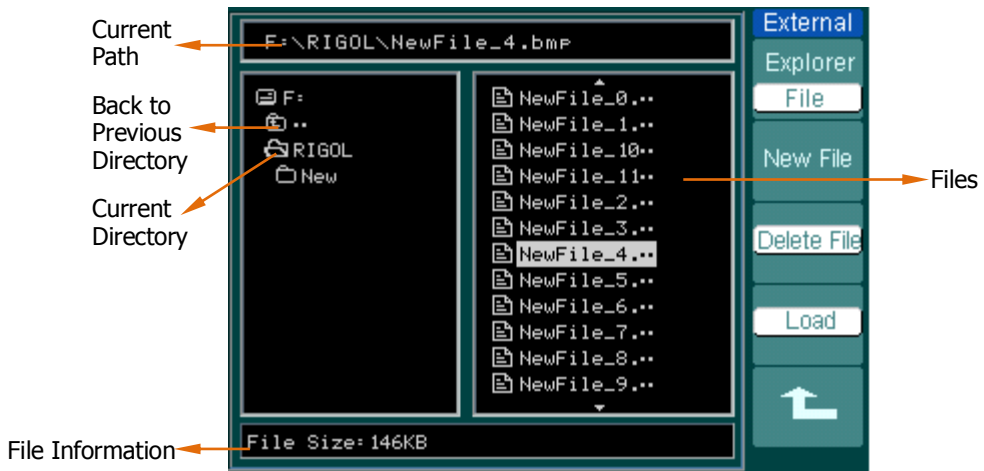

Figure 2-71 File system

Figure 2-72 Table 2-43 The External Memory menu



Menu	Settings	Comments
Explorer	Path Directory File	Switch among Path, Directory and File.
New File (Folder)		To create new file or folder.
Delete File		Delete file (Folder).
Load		Recall waveform and setup from USB storage device.

Disk Management

Press **Storage** → **Disk Mana.** to go to the following menu.

Figure 2-73 Table 2-44 The Disk Management menu (Page 1/2)



Menu	Settings	Comments
Explorer	Path Directory File	Switch among Path, Directory and File.
New folder		To create new folder (same as new files).
Delete File		Delete file.
Load		Recall waveform, setup, recorded waveform, Pass/Fail file.

Figure 2-74 Table 2-45 The Disk Management menu (Page 2/2)



Menu	Settings	Comments
Rename		To rename a file (see Table 2-46).
Disk info		Display disk information.

1. Disk Information

Press **Storage** → **Disk Mana** → **Diskinfo** to go to the disk information interface.

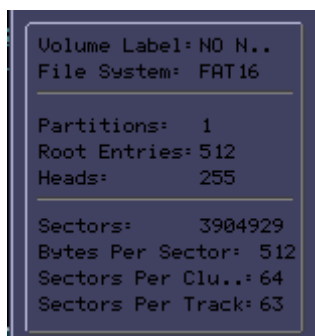

Figure 2-75 Disk information interface

2. Rename

Press **Storage** → **Disk Mana** → **Rename** to go to the following interface.

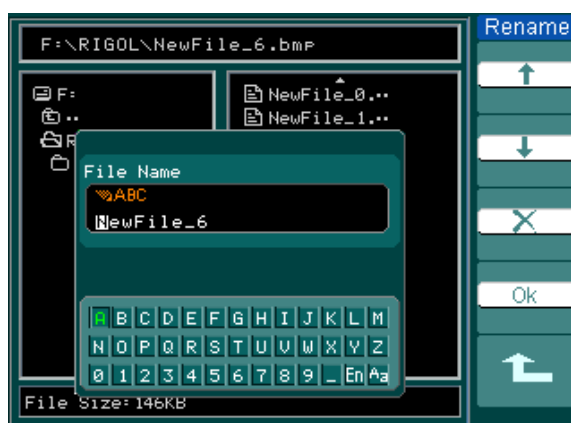

Figure 2-76
Rename the file

Figure 2-77 Table 2-46 The Rename menu



Menu	Settings	Comments
↑		To move the cursor up.
↓		To move the cursor down.
X		To delete chosen letter.
OK		Rename the file.

Key point

Factory: The oscilloscope has default settings and can be recalled at anytime by user.

Memory location: Specify the memory location to save/recall the waveforms and setups.

Load: Recall saved waveforms, setups and default settings.

Save: Save waveforms and setups.

To Set Up the Utility

Figure 2-78 shows the menu button for the Utility on the front panel.

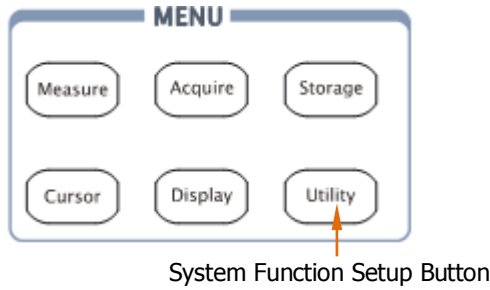

Figure 2-78 Utility button

Press the **Utility** button to show the menu of the settings in the Utility system.

Figure 2-79 Table 2-47 The Utility menu (Page 1/3)



Menu	Setting	Comments
I/O setting		Setup I/O configuration.
Sound	(ON) (OFF)	Turn beeper sound on/off.
Counter	OFF ON	Turn off Frequency Counter. Turn on Frequency Counter.
Language	简体中文 繁体中文 English 日本語 Français ...	Select languages.

Figure 2-80 Table 2-48 The Utility menu (Page 2/3)



Menu	Settings	Comments
Pass/Fail		Setup Pass/Fail test.
Record		Setup Waveform Recorder.
Print set		Setup printing.

Figure 2-81 Table 2-49 The Utility menu (3/3)



Menu	Settings	Comments
Self-Cal		Execute Self-calibration.
Service		Go to service menu.
Preference		Go to preference menu.

Term Explanations:

Self-Cal: Oscilloscope will calibrate parameter of vertical system (CH1, CH2, and Ext), horizontal system and trigger system.

I/O Setup

Press **Utility** → **I/O** setting to go to the following menu.

Figure 2-82 Table 2-50 The I/O Setup menu



Menu	Display	Comments
RS-232 Baud	300 . . 38400	Set RS-232 baud rate as 300, 2400, 4800, 9600, 19200 or 38400.
GPIB#	0 to 30	Set the GPIB address.

Language

The DS1000CA series oscilloscopes have multi-language user menu, choose as your desire.

Press **Utility** → **Language** to select the language.



Figure 2-83 Language interface

Pass/Fail

The Pass/Fail function monitors changes of signals and output pass or fail signals by comparing the input signal is within the pre-defined mask. The testing results not only can be displayed on screen or output by isolated pass/fail port but also can be alarmed if turn on system sound.

Press **Utility** → **Pass/Fail** to go to the following menu.

Figure 2-84 Table 2-51 The Pass/Fail menu (Page 1/2)



Menu	Setting	Comments
Enable Test	ON	Turn on Pass/Fail test.
	OFF	Turn off Pass/Fail test.
Source	CH1	Select Pass/Fail test on CH1.
	CH2	Select Pass/Fail test on CH2.
Operate	▶ (RUN)	Pass/Fail test stopped, press to run.
	■ (STOP)	Pass/Fail test running, press to stop.
Msg display	ON	Turn on Pass/Fail information display.
	OFF	Turn off Pass/Fail information display.

Figure 2-85 Table 2-52 The Pass/Fail menu (Page 2/2)



Menu	Settings	Comments
Output	Fail	Output when Fail condition detected.
	Fail + 🔔	Output and beep when Fail condition detected.
	Pass	Output when Pass condition detected.
	Pass + 🔔	Output and beep when Pass condition detected.
Stop on Output	ON	Stop test when output occur.
	OFF	Continue test when output occur.
Mask Setting		Go to mask setting menu.

1. Mask Setting

Press **Utility** → **Pass/Fail** → **Mask Setting** to go to the following menu.

Figure 2-86 Table 2-53 The Mask setting menu (Page 1/2)



Menu	Settings	Comments
X Mask	<x div>	Set horizontal clearance to the waveform (0.04div-4.00div).
Y Mask	<y div>	Set vertical clearance to the waveform (0.04div-4.00div).
Create Mask		Create a test mask according to the above clearance.
Location	Internal External	Set the memory location of the mask files.

Figure 2-87

Table 2-54 The Mask setting menu (Page 2/2)

When the save as internal memory



Menu	Settings	Comments
Save		Store created test mask into internal memory.
Load		Recall mask setting file from internal memory.
Imp./Exp.		Go to import/export menu (same as REF import/export menu.).

Figure 2-88 Table 2-55 The Mask setting menu (Page 2/2)
When the save as external memory



Menu	Settings	Comments
Save		Go to save menu (same as REF save menu).
Load		Go to load menu (see Table 2-56).
Import		Go to import menu. (The same as REF import menu).

2. Mask Setting

Press **Utility** → **Pass/Fail** → **Mask Setting** → **Load** to go to the following menu.

Figure 2-89 Table 2-56 The Load menu



Menu	Settings	Comments
Explorer	Path Directory File	Switch among Path, Directory and File.
Load		Recall the specified file.

NOTE: Pass/Fail function is unavailable in X-Y mode.

3. Pass/Fail connection

The Pass/Fail connection has an optically isolated output. It needs to connect to another circuit to fulfill the function.

Before connecting to an external circuit, make sure the maximum voltage/current does not exceed the internal photo MOS relay's rating, 400V/100mA. DS1000CA series adopts the technique of Optical Isolation, and the output device has no polarity and can be used in any circuit within the ratings.

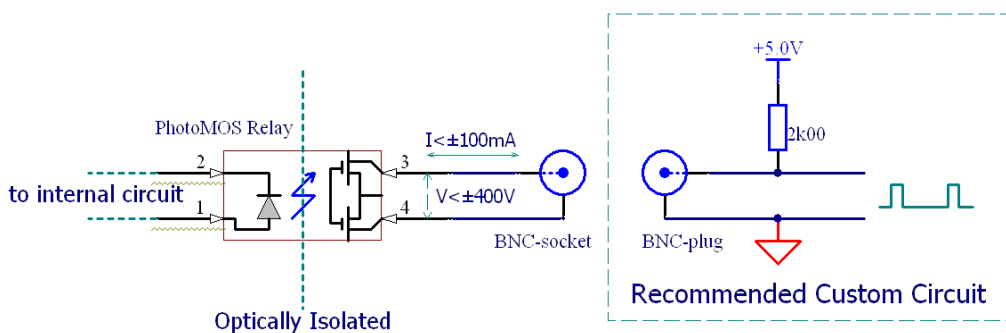

Figure 2-90
Schematic Diagram of Pass/Fail output

Waveform Recorder

Waveform recorder records input waveforms from CH1 and CH2, with a maximum record length of 1000 frames. This performance can also be activated by the Pass/Fail test output, which makes this function especially useful to capture abnormal signals in long term without keeping an eye watching it. This function contains four modes: OFF, Record, Play back and Storage. More details about the function please refer to the following introduction.

1. **OFF:** It will close all record functions.
2. **Record:** To record waveform by selected time interval till the last frame.

Press **Utility** → **Record** → **Mode** → **Record** to go to the following menu

Figure 2-91 Table 2-57 The Record menu (Page 1/2)



Menu	Settings	Comments
Mode	OFF Record Play back Storage	Turn off all recorder functions. Select record mode. Select play back mode. Select storage mode.
Source	CH1 CH2 P/F-OUT	Select record source channel.
End Frame	 <1-1000>	Set number of record frames.
Operate	(Run) (Stop)	Record stopped, press to Start recording. Press to stop recording.

Figure 2-92 Table 2-58 The Record menu (Page 2/2)



Menu	Settings	Comments
Interval	<1.00ms-1000s>	Set time interval between record frames.

3. Play back: Play back the recorded waveforms.

Figure 2-93 Table 2-59 The Play Back menu (Page 1/2)



Menu	Settings	Comments
Operate	(Run)	Play stopped, press to Start playback.
	(Stop)	Press to stop playing.
Play mode		Set repeat play mode.
		Set single time play mode.
Interval	<1.00ms-20s>	Set up interval.

Figure 2-94 Table 2-60 The Play Back menu (Page 2/2)

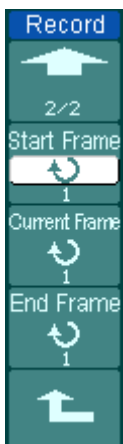

Menu	Settings	Comments
Start Frame	<1-1000>	Set start frame.
Current Frame	<1-1000>	Select current frame to be played.
End Frame	<1-1000>	Set End frame.

Key Points

The **RUN/STOP** button can also replay or continue the waveform display.

- 4. **Storage:** Store recorded waveforms to non-volatile memory according to the setup frames.

Figure 2-95 Table 2-61 The Storage menu (Page 1/2)

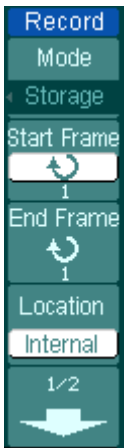

Menu	Settings	Comments
Start Frame	<1-1000>	Set first frame to be saved.
End Frame	<1-1000>	Set last frame to be saved.
Location	Internal external	Set up Store location.

Figure 2-96 Table 2-62 The Storage menu when the save to Internal memory (Page 2/2)



Menu	Settings	Comments
Save		Save recorded waveform to internal memory location.
Load		Recall recorded waveform from internal memory location.
Imp./Exp.		Go to import/export menu (Same as REF import/export menu).

Figure 2-97 Table 2-63 The Storage menu when the save as external memory
(Page 2/2)



Menu	Settings	Comments
Save		Go to save menu (same as REF save menu).
Load		Go to load menu (see Table 2-56).
Import		Go to import menu. (Same as REF import menu).

Print Set

DS1000CA series oscilloscopes support external printers.

Press **Utility** → **Print set** to go to the following menu.

Figure 2-98 Table 2-64 The Print Set menu



Menu	Settings	Comments
Print		Execute print function.
Inverted	ON OFF	Invert the color for print. Print original color.
Palette	Gray scale Color	Set up print color.

Self-Calibration

The Self-Calibration adjusts the internal circuitry to get the best accuracy. Use these functions to calibrate the vertical and horizontal systems. For maximum accuracy at any time, run this calibration if the ambient temperature changes by 5°C or more.

Before running this procedure, make sure that disconnect any probes or cables from all channel inputs, otherwise failure or damage to the oscilloscope may occur. Then, press **Utility** → **Self-Cal.**

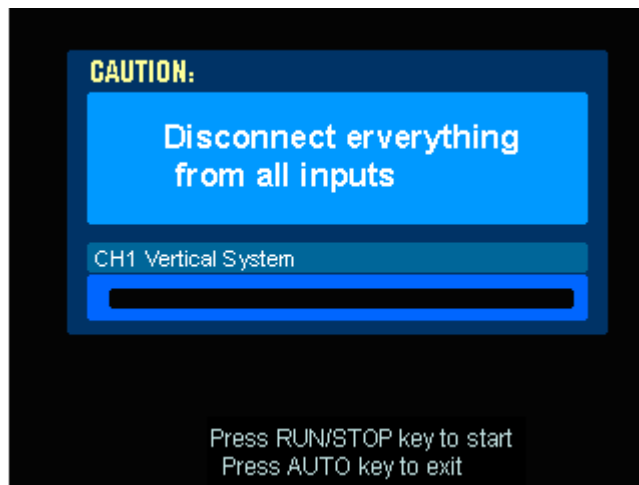

Figure 2-99 The Self-Calibration menu

NOTE: The oscilloscope must have been working or warm-up **at least 30 minutes** before running self-calibration to get best accuracy.

Service

Press **Utility** → **Service** to go to the following menu.

Figure 2-100 Table 2-65 The Service menu



Menu	Settings
System Info	Press to display system information.
Color Test	Press to run color test.

1. System Information

Press **Utility** → **Service** → **System Info** to display the information of the oscilloscope. Product Model, Serial No. Software version and Installed module of the oscilloscope. Follow the prompting message "<<Press 'RUN/STOP' Key to Exit the Test>>" to exit this interface.

2. Color Test

Select **Color Test** to enter the color test screen, the hue, saturation, brightness, or red, green and blue components can be adjusted by turning the (↻) knob, confirm selection by pushing the (↻) knob.

Preference

Press **Utility** → **Preference** to go to the following menu

Figure 2-101 Table 2-66 The Preference menu (Page 1/2)



Menu	Display	Comments
Screen saver	1 min . . 5 hour OFF	Set up screen saver timer.
Expand Refer.	Ground Center	Set up waveform vertical expand reference.
Screen Persist	 	Set the Screen waveforms persist or display the last sampling waveforms in stopping moment.
Skin	Classical Modern Tradition Succinct	Set up skin style.

Figure 2-102 Table 2-67 The Preference menu (Page 2/2)

Menu	Display	Comments
Sticky key		Set up sticky state of CH1, CH2, MATH, REF, Trig. Lev. and Trig. Pos.
Command		RIGOL or TEK

Key Points

Screen saver: If oscilloscope is free for a pointed time, screen saver function can be used. This function extends the life of LCD backlighting system.

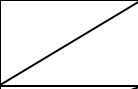
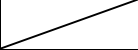
Expand reference: When changing the volts/div. for channels, the signal expands or compresses around the signal ground level, or the center of the screen. When **Center** is selected, the waveform will expand or compress around the center of the display. When **Ground** is selected, the channel ground level will remain the same position on the display and waveform will zoom about the ground level.

Sticky key: If sticky feature is turned ON, when adjusting positions (CH1, CH2, MATH, REF, Trig. Lev. and Trig. Pos.), the object will stop at zero position until next adjustment, for the ease of getting back to initial positions.

To Measure Automatically

The **Measure** button in the menu area activates the automatic measurement function. The instruction below shows the powerful measurement function of DS1000CA series oscilloscopes.

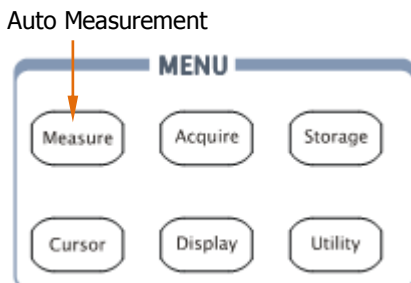

Figure 2-103 Measure button

The oscilloscopes provide 20 auto measurements: Vpp, Vmax, Vmin, Vtop, Vbase, Vamp, Vavg, Vrms, Overshoot, Preshoot, Freq, Period, Rise Time, Fall Time, Delay1-2 \overline{f} , Delay1-2 \overline{t} , +Width, -Width, +Duty, -Duty (10 voltage and 10 timing measurements).

Press the **Measure** button to display the menu of the Automatic Measurements settings.

Figure 2-104 Table 2-68 The Measure menu



Menu	Settings	Comments
Source	CH1 CH2	Select CH1 or CH2 as source channel for measurement.
Voltage		Select to measure voltage parameter.
Time		Select to measure time parameter.
Clear		Clear measurement result on screen.
Display All	OFF ON	Turn off all measurement result. Turn on all measurement result.

1. Page 1 for Voltage Measurements

Figure 2-105 Table 2-69 The Voltage Measurement menu



Menu	Settings	Comments
Maximum		Measure maximum voltage of a waveform.
Minimum		Measure minimum voltage of a waveform.
Peak-Peak		Measure Peak-to-Peak Voltage.
Top		Measure a flat top voltage of a square waveform.

2. Page 2 for voltage measurements

Figure 2-106 Table 2-70 The Voltage Measurement menu



Menu	Settings	Comments
Base		Measure a flat base voltage of a square waveform.
Amplitude		Measure voltage between Top and Base.
Average		Measure average voltage of a waveform.
RMS		Measure Root Mean Square Voltage of a waveform.

3. Page 3 for Voltage Measurements

Figure 2-107 Table 2-71 The Voltage Measurement menu



Menu	Settings	Comments
Overshoot		Measure overshoot in percentage of an edge.
Preshoot		Measure preshoot in percentage of an edge.

4. Page 1 for Time Measurements

Figure 2-108 Table 2-72 The Time Measurement menu



Menu	Settings	Comments
Period		Measure Period of a waveform.
Freq		Measure Frequency of a waveform.
Rise time		Measure Rise Time of a rising edge.
Fall time		Measure Fall Time of a falling edge.

5. Page 2 for Time Measurements

Figure 2-109 Table 2-73 The Time Measurement menu

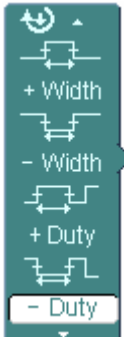

Menu	Settings	Comments
+Width		Measure +Pulse Width of a pulse wave.
-Width		Measure -Pulse Width of a pulse wave.
+Duty		Measure +Duty Cycle of a pulse wave.
-Duty		Measure -Duty Cycle of a pulse wave.

6. Page 3 for Time Measurements

Figure 2-110 Table 2-74 The Time Measurement menu



Menu	Settings	Comments
Delay1→2 f		Measure the signals delay between two channels at the rising edge.
Delay1→2 t		Measure the signals delay between two channels at the falling edge.

NOTE: The results of the automatic measurements will be displayed on the bottom of the screen. Maximum 3 results could be displayed at the same time. When there is no room, the next new measurement result will make the previous results moving left out of screen.

Operation Explanation:

1. Select the signal channel for measuring. CH1 or CH2 according to the signal of interest.
Press soft buttons as follows: Measure → Source → CH1 or CH2.
2. To see all measurement values, set the Display All to ON. 18 measurement parameters will be displayed on the screen (except for "Delay1 → 2f" and "Delay1 → 2τ").
3. Select parameters page for measuring; select voltage or time parameters pages by pressing soft button as follows: Measure → Voltage or time → Vmax, Vmin.....
4. To get the measured value on the screen; select the parameters of interest by pressing the soft button on the right of the menu, and read the data on the bottom of the screen.
If the data is displayed as "*****", it means the parameter cannot be measured in current condition.
5. Clear the measure values: press Clear and all of the auto measure values would disappear from the screen (except for "Display all" parameters).

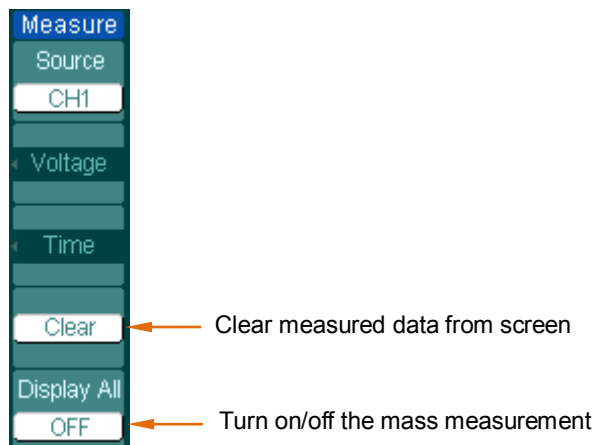

Figure 2-111 Measure menu

Automatic measurement of voltage parameters

The DS1000CA series oscilloscopes provide automatic voltage measurements including V_{pp} , V_{max} , V_{min} , V_{avg} , V_{amp} , V_{rms} , V_{top} , V_{base} , **Overshoot** and **Preshoot**. Figure 2-112 below shows a pulse with some of the voltage measurement points.

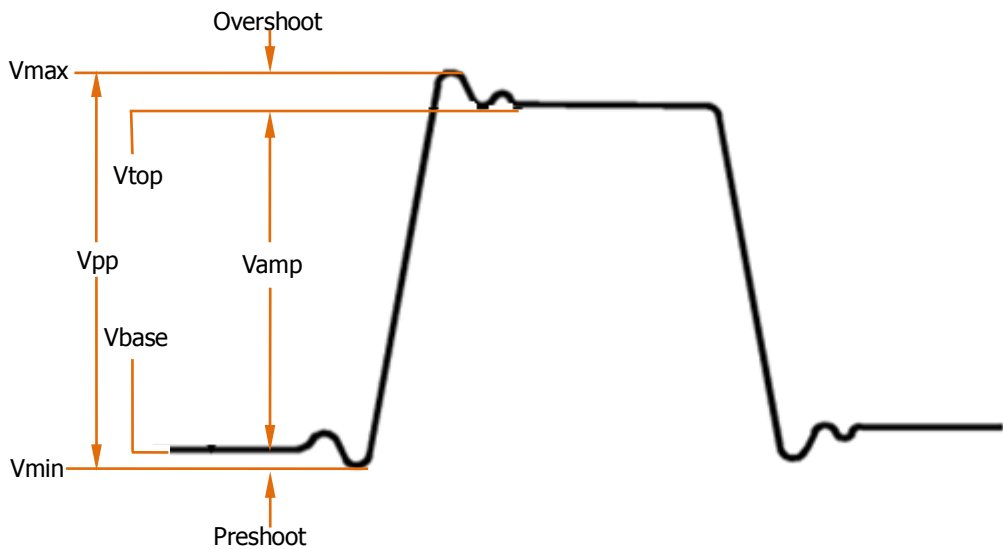

Figure 2-112
Voltage parameters

V_{pp} : Peak-to-Peak Voltage.

V_{max} : The maximum amplitude. The most positive peak voltage measured over the entire waveform.

V_{min} : The minimum amplitude. The most negative peak voltage measured over the entire waveform.

V_{amp} : Voltage between V_{top} and V_{base} of a waveform

V_{top} : Voltage of the waveform's flat top, useful for square/pulse waveforms.

V_{base} : Voltage of the waveform's flat base, useful for square/pulse waveforms.

****Overshoot:**** Defined as $(V_{max}-V_{top})/V_{amp}$, useful for square and pulse waveforms.

****Preshoot:**** Defined as $(V_{min}-V_{base})/V_{amp}$, useful for square and pulse waveforms.

****Average:**** The arithmetic mean over the entire waveform.

V_{rms} : The true Root Mean Square voltage over the entire waveform.

Automatic measurement of time parameters

DS1000CA series oscilloscopes provide timing parameters auto-measurements; Frequency, Period, Rise Time, Fall Time, +Width, -Width, Delay 1→2 f , Delay 1→2 t , +Duty and -Duty.

Figure 2-113 shows a pulse with some of the time measurement points.

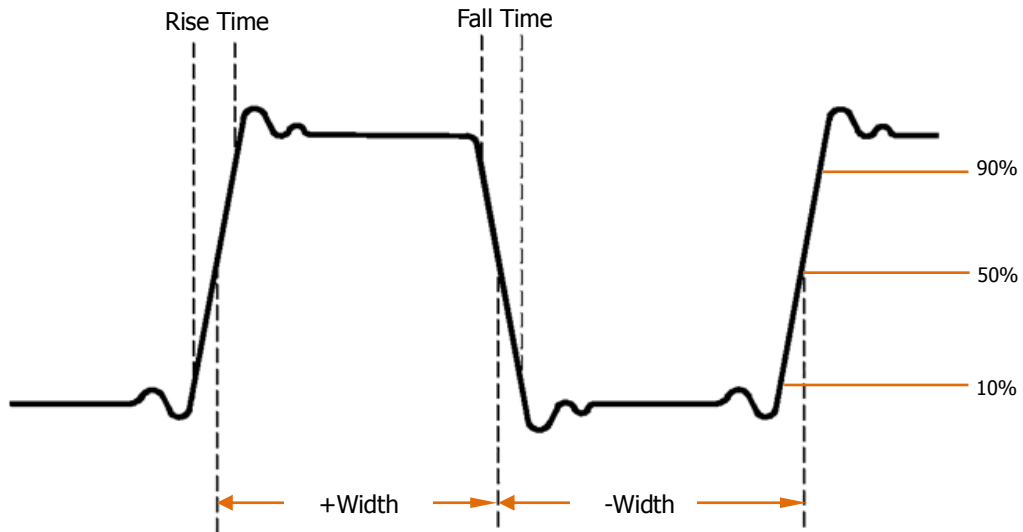

Figure 2-113
The time parameters

Rise Time: Time that the leading edge of the first pulse in the waveform takes to rise from 10% to 90% of its amplitude.

Fall Time: Time that the falling edge of the first pulse in the waveform takes to fall from 90% to 10% of its amplitude.

+Width: The width of the first positive pulse in 50% amplitude points.

-Width: The width of the first negative pulse in the 50% amplitude points.

Delay 1→2 f : The delay between the two channels at the rising edge.

Delay 1→2 t : The delay between the two channels at the falling edge.

+Duty: +Duty Cycle, defined as +Width/Period

-Duty: -Duty Cycle, defined as -Width/Period

To Measure with Cursors

Figure 2-112 shows the **Cursor** button on the front-panel.

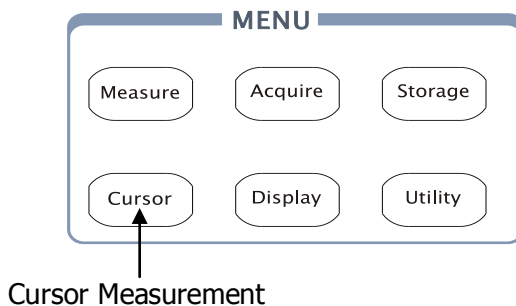

Figure 2-114 Cursor button

The cursor measurement has three modes: Manual, Track and Auto Measure.

1. Manual:

In this mode, the screen displays two parallel cursors. Move the cursors to make custom voltage or time measurements of the signal. The values are displayed on the boxes below the menu. Before using cursors, make sure to set the Signal Source as the channel for measuring.

2. Track:

In this mode, the screen displays two cross cursors. The cross cursor sets the position on the waveform automatically. Adjust cursor's horizontal position on the waveform by rotating the multifunctional knob (↻). The oscilloscope displays the values of the coordinates on the boxes below the menu.

3. Auto Measure:

This mode will take effect with Automatic Measurements. The instruments will display cursors while measuring parameters automatically. These cursors demonstrate the electrical meanings of these measurements.

NOTE: The Auto Measure mode for Cursor measuring will take no effect without automatic measurements.

Manual Mode

Press **Cursor** → **Mode** → **Manual** to display the manual mode menu.

Figure 2-115 Table 2-75 Manual mode menu



Menu	Settings	Comments
Mode	Manual	Adjust the cursor to measure X/Y parameters manually.
Type	X	Shown as vertical line to measure the horizontal parameters.
	Y	Shown as horizontal line to measure the vertical parameters.
Source	CH1 CH2 MATH/FFT	Select the measurement signal source.
CurA		Set CurA effective and adjust it.
CurB		Set CurB effective and adjust it.

In this mode, the oscilloscope measures the Y or X coordinate values of the cursors, and the increments between the two cursors.

To do manual Cursor Measurements, please do as the following steps:

1. Select the **Manual** mode for cursor measurement by pressing soft button as: **Cursor** → **Mode** → **Manual**.
2. Select the cursors type by pressing soft button as **Cursor** → **Type** → **X** or **Y**.
3. Select channel **Source** for measurements by pressing soft button as: **Cursor** → **Source** → **CH1**, **CH2** or **MATH/FFT**.
4. Move the cursors to adjust the increment between the cursors: (Details in the following Table)

Table 2-76 The Cursor menu

Cursor	Increment	Operation
Cursor A	X	Turn the multifunctional knob (↻) to move cursor A horizontally.
	Y	Turn the multifunctional knob (↻) to move cursor A vertically.
Cursor B	X	Turn the multifunctional knob (↻) to move cursor B horizontally.
	Y	Turn the multifunctional knob (↻) to move cursor B vertically.

NOTE: Cursor could be moved only when the curse function menu is displayed.

5. To get measurement values:

Position of Cursor A (Time cursor centered on the midpoint of screen; Voltage cursor centered on channel ground level).

Position of Cursor B (Same as above).

Horizontal space between cursor A and B (ΔX): Time between cursors ($1/\Delta X$), units in Hz, kHz, MHz, GHz.

Vertical space between cursor A and B (ΔY): Voltage between cursors.

NOTE: The values will be automatically displayed on the right upper corner of screen when the cursor function menu is hidden or displaying other menus.

Term Explanations:

Cursor Y: Cursors Y appear as horizontal lines on the display to measure vertical parameters. Usually it is used to measure the Volts. When the source is set as function, the units are assigned to the function.

Cursor X: Cursor X appears as vertical lines on the display to measure horizontal parameters. Usually it indicates the time of trigger excursion. When the source is set as FFT, X means frequency.

Track Mode

Press **Cursor** → **Mode** → **Track** to display the track mode menu.

Figure 2-116 Table 2-77 Track mode menu

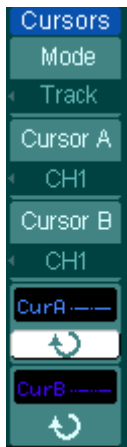

Menu	Settings	Comments
Mode	Track	Set Track mode in cursor measurement.
Cursor A	CH1 CH2 None	Set Cursor A in conjunction with CH1, CH2 or turn off Cursor A.
Cursor B	CH1 CH2 None	Set Cursor B in conjunction with CH1, CH2 or turn off Cursor B.
CurA (Cursor A)	↔	Turn the multifunctional Knob (↻) to move cursor A Horizontally.
CurB (Cursor B)	↔	Turn the multifunctional knob (↻) to move cursor B horizontally.

In Track mode, the cross cursor is displayed on the waveform under measuring. If you move the horizontal position of cursor, the horizontal coordinate and vertical coordinate of current point as well as the increments of them will be displayed immediately. Note: horizontal coordinate represents time value, vertical coordinate represents voltage value.

To do Track mode Cursor Measurements, follow these steps:

1. Select the **Track** mode for cursor measurement by pressing soft button as: **Cursor** → **Mode** → **Track**.
2. Select channel **Source** for Cursor A and Cursor B by pressing soft button as: **Cursor** → **Cursor A** or **Cursor B** → **CH1**, **CH2** or **None**.
3. Move the cursors to adjust the horizontal positions of the cursors:

Table 2-78 The Cursor usage

Cursor	Operation
Cursor A	Turn the multifunctional knob (↻) to move cursor A horizontally.
Cursor B	Turn the multifunctional knob (↻) to move Cursor B horizontally.

NOTE: Moving cursor horizontally is not allowed when other (not tracking cursor) menu is activated.

4. To get measurement values:

- Position of Cursor A (Time cursor centered on the midpoint of screen; Voltage cursor centered on channel ground level).
- Position of Cursor B (Time cursor centered on the midpoint of screen; Voltage cursor centered on channel ground level).
- Read the horizontal space between Cursor A and B (ΔX): Time between cursors, units in seconds.
- $(1/\Delta X)$, units in Hz, kHz, MHz, GHz.
- Vertical space between cursor A and B (ΔY): Voltage between cursors, units in V.

Auto Mode

Press **Cursor** → **Mode** → **Auto** to display the auto mode menu.

Figure 2-117 Table 2-79 Auto mode menu



Menu	Settings	Comments
Mode	Auto	Display the cursors for the current automatic measuring. (See the following figure).

There will be no cursor display if no parameters are chosen in Measure menu. The oscilloscope could move cursor automatically to measure 20 parameters in **Measure** menu.

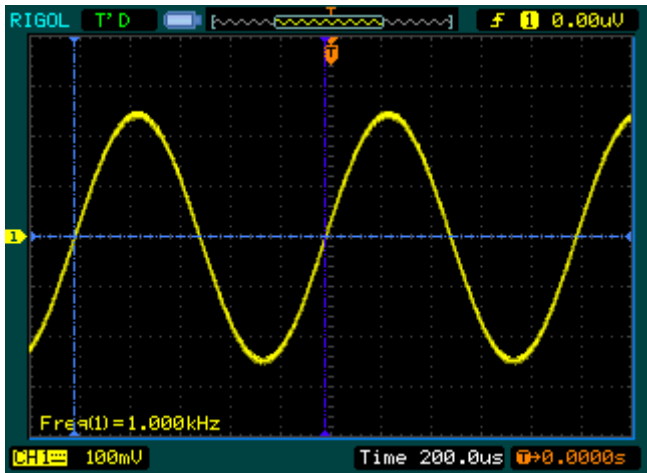

Figure 2-118
Auto Measure Mode of Cursor Measurement





To Use Run Control Buttons

The RUN control buttons include **AUTO** (auto setting) and **RUN/STOP**.

AUTO: The **AUTO** features automatic adjustments to produce a stable display of the input signal. Press **AUTO** button, the following menu appears.

Figure 2-119 Table 2-80 The Auto menu



Menu	Settings	Comments
 Multi-Cycle	/	Press to display multi-cycle waveform on the screen.
 Single Cycle	/	Press to display single cycle waveform on the screen.
 Rise Edge	/	Press to display the waveform's rising edge and measure its rise time automatically.
 Fall Edge	/	Press to display falling edge of the waveform and measure fall time automatically of it.
 (Cancel)	/	Press to cancel all the Auto Set actions, the oscilloscope will recover to its previous status.

Auto-Set functions

When the **AUTO** is pressed the oscilloscope is configured to the following defaults:

Table 2-81 The Auto menu

Menu	Settings
Display format	Y-T
Acquire mode	Normal
Vertical position	Adjust to right position
Vertical "Volts/div"	Adjusted
Volts/Div	Coarse
Bandwidth limit	OFF* (Full bandwidth)
Signal Invert	OFF
Horizontal position	Center
Horizontal "S/div"	Adjust to right position
Trigger type	Edge
Trigger source	Find the channel with input signal automatically.
Trigger coupling	DC
Trigger voltage	Midpoint setting
Trigger mode	Auto

NOTE*: When measuring small signal, the Bandwidth limit will be turned on automatically.

RUN/STOP: Run or Stop waveform acquiring.

NOTE: In STOP status, the volts/div and horizontal time base can be adjusted in a fixed limit. That is, to zoom in/out the signal in vertical and horizontal directions.

Chapter 3 Application & Examples

Example 1: Taking Simple Measurements

The function is used to observe an unknown signal; to display, measure frequency, and peak-to-peak amplitude.

1. To quickly display a signal, please do the steps as follow:

- (1) Set the probe and the channel attenuations to 10X.
- (2) Connect signal to CH1 with the probe.
- (3) Press the **AUTO** button.

The oscilloscope sets the vertical, horizontal, and trigger controls at the best status automatically. To optimize the waveform display, adjust these controls manually to meet the requirements.

2. Selecting Automatic Measurements

The oscilloscope takes automatic measurements on most signals. To measure the frequency and the peak-to-peak amplitude, do these steps as follows:

(1) Measure peak-to-peak amplitude.

Press **Measure** → **Source** → **CH1** to set the measurement source

Press **Voltage** → **Peak-Peak** to select the peak-to-peak measurements and the result will be displayed on the screen.

(2) Measure frequency.

Press **Measure** → **Source** → **CH1** to set the measurement source

Press **Time** → **Freq** to select the frequency measurements and the result will be displayed on the screen.

NOTE: The frequency and peak-to-peak measurements are shown on the screen and are updated periodically.

Example 2: View a Signal Delay Caused by a Circuit

This example is to test the input and output signals of a circuit and observe the signal delay. First, set the probe and the channel attenuation to 10X and connect CH1 probe to the input, CH2 to the output of the circuit.

Do these steps as follow:

1. Display the signals (CH1 and CH2):
 - (1) Press the **AUTO** button.
 - (2) Adjust the vertical and the horizontal scale by turning the **SCALE** knobs to appropriate ranges for display.
 - (3) Press the **CH1** button to select Channel 1, and turn the vertical **POSITION** knob to adjust the vertical position of Channel 1 waveform.
 - (4) Press the **CH2** button to select Channel 2, and turn the vertical **POSITION** knob to adjust the vertical position of Channel 2 waveform.
2. Measure the delay time when a signal going through the circuit.
 - (1) Auto-measuring the delay:
Press **Measure** → **Source** → **CH1** to set the measurement source.
Press **Time** to select the measurement Type.
Press **Delay 1** → **2** to display the result on the screen.
 - (2) You can see the change of the waveform in the following figure:

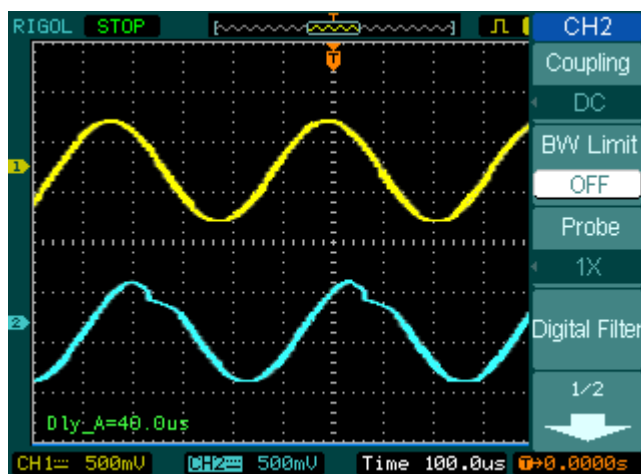

Figure 3-1 Waveform distortion

Example 3: Capture a Single-Shot Signal

To capture a single event, it needs to gather some pre-test knowledge of the signal in order to set up the trigger level and slope correctly. For example, if the event is derived from TTL logic, a trigger level of 2 volts should work on a rising edge.

The following steps show how to use the oscilloscope to capture a single event.

1. Set the probe and the channel attenuations to 10X.
2. Set up the trigger.
 - (1) Press the **MENU** button in the Trigger control area to display the menu.
 - (2) Press **Edge** to select the trigger mode. Press **Slope** to select **f**. Press **Source** to select **CH1**. Press **Sweep** to select **Single**. Press **Set Up** → **Coupling** to select **DC**.
 - (3) Turn the vertical and horizontal **SCALE** knobs to adjust the Volts/Div and the Time base in a proper range for the signal.
 - (4) Turn the **LEVEL** knob to adjust trigger level.
 - (5) Press **RUN/STOP** button to start capturing. When the trigger conditions are met, data appears on the display representing the data points that the oscilloscope obtained with one acquisition.

This function helps to capture the occurrence easily, such as the noisy with large amplitude; set the trigger level higher a little above the normal level and press **RUN/STOP** and wait. When noise occurs, the instrument will record the waveform before and after the trigger. Adjust the **POSITION** button in the horizontal control area and change the level of the trigger position, will get the inverted delay trigger. It is useful to observe the waveform before the occurrence of the noise.

Example 4: To Reduce the Random Noise on a Signal

If the signal is noisy (Figure 3-2), set up the oscilloscope to reduce the noise on the waveform and avoid its interference to the signal.

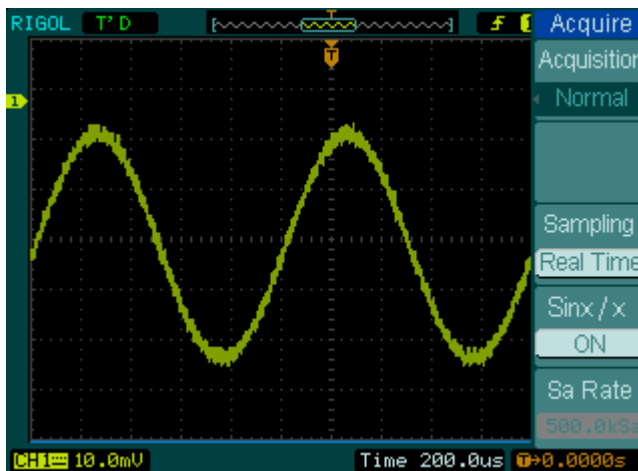

Figure 3-2 Signal with noise

1. Set the probe and the channel attenuations to 10X.
2. Connect a signal to the oscilloscope and obtain a stable display.
3. Improve the trigger by setting the Coupling.
 - (1) Press the **MENU** in the Trigger control area.
 - (2) Press **Set Up**→**Coupling**→**LF Reject** or **HF Reject**.

HF Reject (High frequency reject) adds a low pass filter with the -3 dB cut-off point at 150 kHz. Use HF rejects to remove high frequency noise such as AM or FM broadcast stations from the trigger path.

LF Reject (Low frequency reject) adds a high pass filter with the -3 dB cut-off point at 8 kHz. Use LF Reject to remove low frequency signals such as power line noise from the trigger path.
4. To reduce the noise by setting the acquisition type and adjust the waveform intensity.

- (1) If there is noise within the signal and the waveform looks too wide, in this case, choose average acquisition. In this mode the waveform will be thin and easy to observe and measure.

To use average follow these steps.

- Press soft button as **Acquire** → **Acquisition** → **Average**.
- Toggle the **Averages** soft button to select the number of averages that best eliminates the noise from the displayed waveform. It can be adjusted from 2-256. (See Figure 3-3)

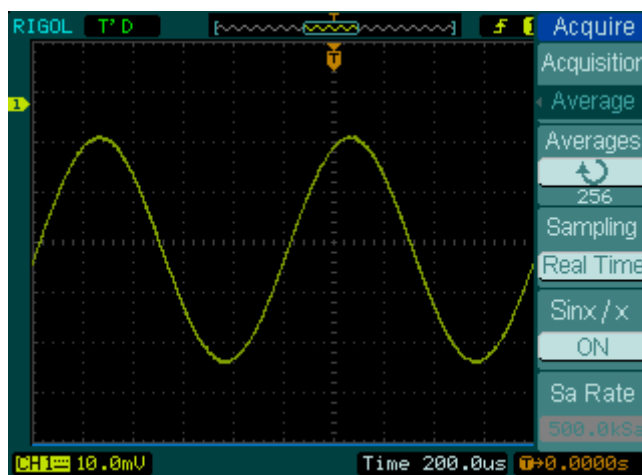

Figure 3-3 Signal without noises

- (2) To reduce the noise it can also be achieved by reducing the intensity of the display.

NOTE: It is normal that the refresh rate will slow down when the average acquisition mode is ON.

Example 5: Making Cursor Measurements

There are 20 build-in automatic measurements. They can also be conducted using cursors to make time and voltage measurements of a waveform quickly.

Measure the Peak Frequency of the First Sinc Waveform

To measure the ringing frequency at the rising edge of a signal, do these steps:

1. Press **Cursor** key to see the Cursor menu.
2. Press **Mode** to set **Manual** mode.
3. Press **Type** to select **X**.
4. Turn (↻) knob to place cursor A on the first peak of the wave.
5. Turn (↻) knob to place cursor B on the second peak of the wave.

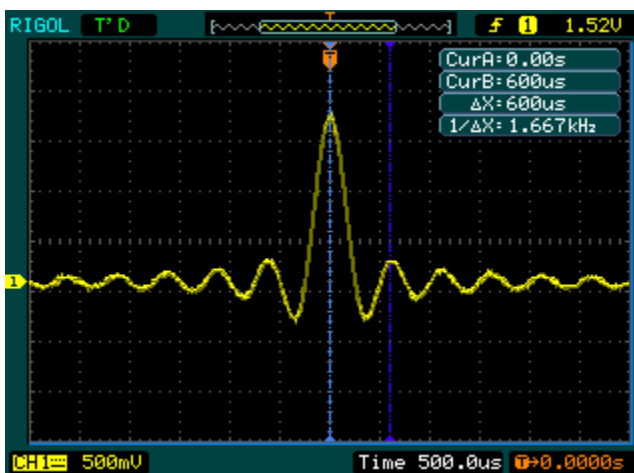

Figure 3-4 Waveform display

Observe the delta in time and frequency displayed on the screen.

Measure the Amplitude of the First Waveform Peak of the Sinc.

Please follow these steps:

1. Press **Cursor** key to see the Cursor menu.
2. Press **Mode** to set **Manual** mode.
3. Press **Type** to select **Y**.
4. Turn (↻) knob to place cursor A on the first peak of the wave.
5. Turn (↻) knob to place cursor B on the second peak of the wave.

Observe the following measurements in the cursor menu: (See Figure 3-5)

- The delta voltage (peak-to-peak voltage of the waveform)
- The voltage at Cursor 1
- The voltage at Cursor 2

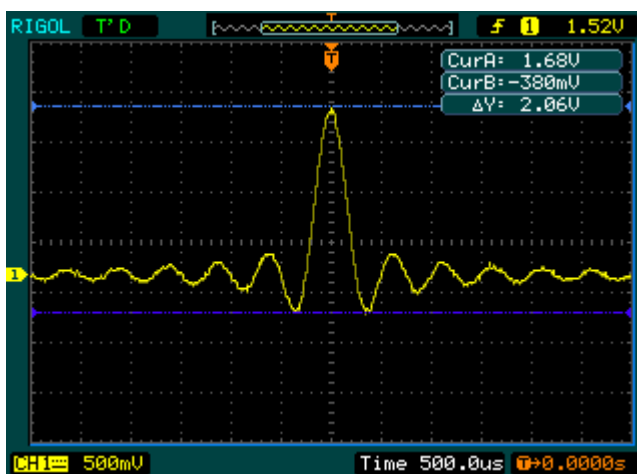

Figure 3-5 Waveform display

Example 6: The application of the X-Y operation

Viewing Phase Changes through a Network

Theme: Connect the oscilloscope to monitor the input and output of the circuit and capture the phase changes.

To view the input and output of the circuit in an X-Y display, do these steps:

1. From the probe menu set the attenuation to 10X. Set the switch to 10X on the probes.
2. Connect the CH 1 probe to the input of the network, and connect the CH 2 probe to the output.
3. If the channels are not displayed, press the **CH1** and **CH2** buttons.
4. Press the **AUTO** button
5. Adjust the vertical **SCALE** knob to display approximately the same amplitude signals on each channel.
6. Press the **MENU** in horizontal control area to display the menu
7. Press the **Time Base** soft button to select X-Y.

The oscilloscope displays a Lissajous pattern representing the input and output characteristics of the circuit.

8. Adjust the vertical **SCALE** and **POSITION** knobs to a desirable waveform display.
9. Apply the Ellipse method to observe the phase difference between the two channels.

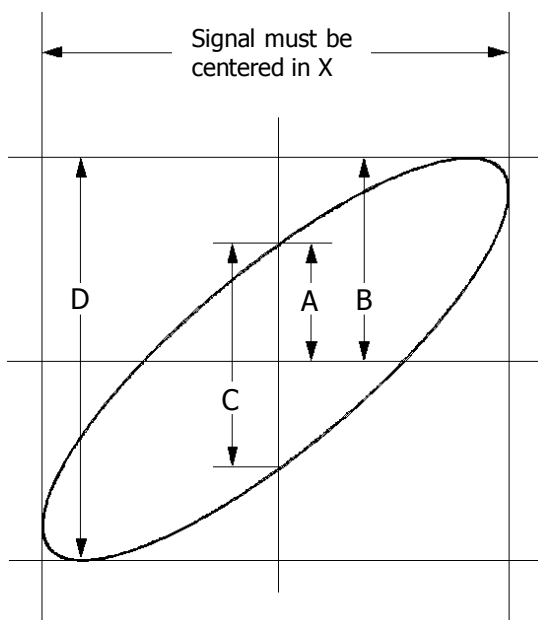

Figure 3-6

Ellipse method to observe the phase difference

$\text{Sin}\theta = \mathbf{A/B}$ or $\mathbf{C/D}$, where θ = phase shift (in degrees) between the two signals.
From the formula above, you could get:

$$\theta = \pm\text{arcsine}(\mathbf{A/B}) \text{ or } \pm\text{arcsine}(\mathbf{C/D})$$

If the main axis of the ellipse is at I and III quadrant, θ must be in the range of $(0\sim\pi/2)$ or $(3\pi/2\sim2\pi)$. If the main axis is at II and IV quadrant, θ must be in the range of $(\pi/2\sim\pi)$ or $(\pi\sim3\pi/2)$.

Example 7: Triggering on a Video Signal

Test a video circuit in the DVD set. Use video trigger to obtain a stable display.

Triggering on Video Fields

To trigger on the video fields, please do as the following steps:

- 1 Press the **MENU** key in the Trigger control area to see the Trigger menu.
- 2 Press **Mode** to select **Video**.
- 3 Press **Source** to select **CH1** as trigger source.
- 4 Press **Polarity** to select **┌┐**.
- 5 Press **Sync** as **Odd Field** or **Even Field**.
- 6 Adjust the **LEVEL** to set trigger level at the video sync pulse to get stable trigger.
- 7 Turn the horizontal **SCALE** knob to see a complete waveform on the screen.

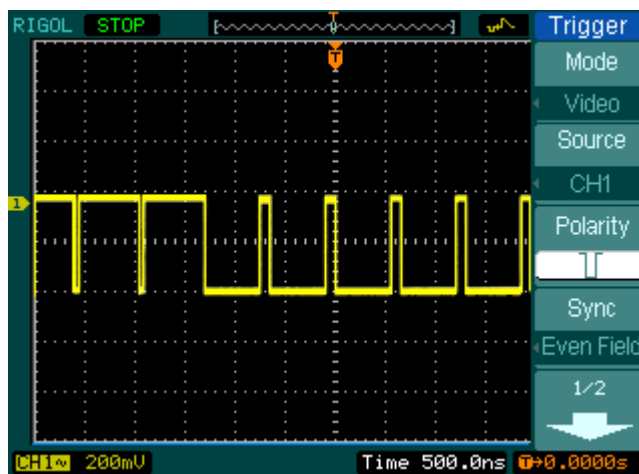

Figure 3-7 Waveform display

DS1000CA series triggers on the Odd field or Even field. To avoid confusion when Odd field and Even field trigger simultaneously, choose Odd field or Even field as in step 5 above.

Triggering on the Video Lines

1. Press the **MENU** key in the Trigger control area to see the trigger menu.
2. Press **Mode** to select **Video**.
3. Press **Source** to select **CH1** as trigger source.
4. Press **Polarity** to select **↓**.
5. Press **Sync** to select **Line Num**.
6. Turn (⌚) knob to trigger on a specified line number.
7. Adjust the **LEVEL** knob to set trigger level at the video sync pulse to get a stable trigger.
8. Turn the horizontal **SCALE** knob to observe a complete waveform on the screen.

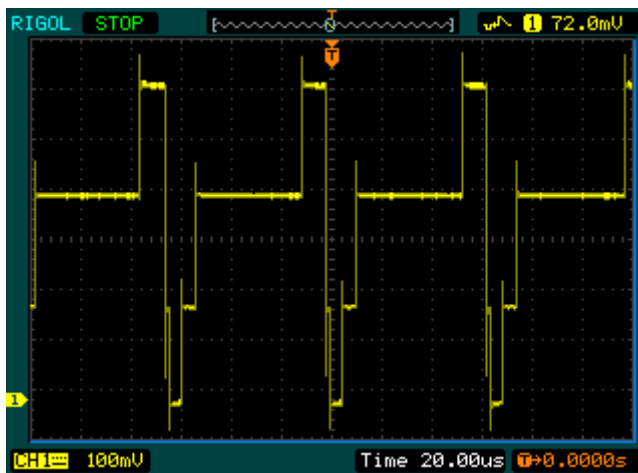

Figure 3-8 Waveform display

Example 8: FFT Cursor Measurement

FFT measurements include: Amplitude measurement (V_{RMS} or dBV_{RMS}) and Frequency measurement (Hz).

Do these steps as follow:

1. Press **Cursor** → **Manual**.
2. Press **Type** to select X or Y.
3. Press **Source** to select **FFT**.
4. Turn (↻) knob to move the cursor to a point of interest.

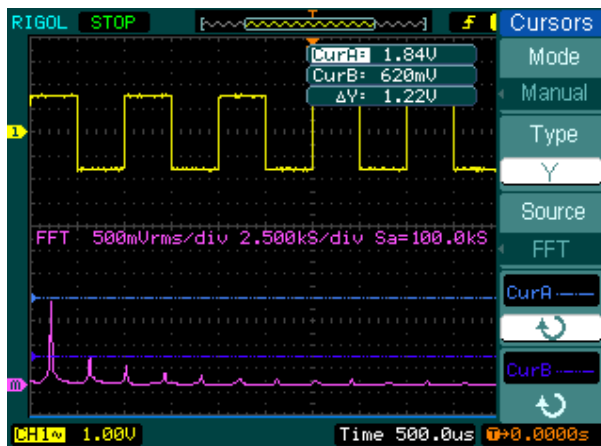

Figure 3-9 Cursor amplitude measurement

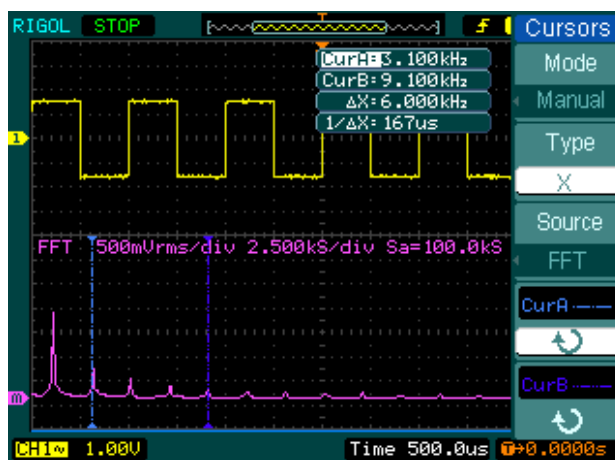

Figure 3-10 Cursor frequency measurement

Example 9: Pass/Fail Test

The Pass/Fail Test is one of enhanced special functions based on DS1000CA series. In this test function the oscilloscope, compares the input signal to the established waveform mask. If the waveform "touches" the mask, a "Fail" signal occurs, otherwise the test passes. When needed, a programmable output can be used for external automatic control applications. The output is built in as a standard feature, and is optically isolated.

Do the steps as following:

1. Press **Utility** → **Pass/Fail**.
2. Press **Enable Test** and select **ON**.
3. Press **Mask Setting** → **Load**.
4. Press **Load** to recall the saved mask or press **X Mask** and **Y Mask** to adjust the horizontal limit and vertical limit then press **Create Mask** to create a new mask.
5. Press **Output** to select the expected outputting waveforms.
6. Press **Operate** to start the test.

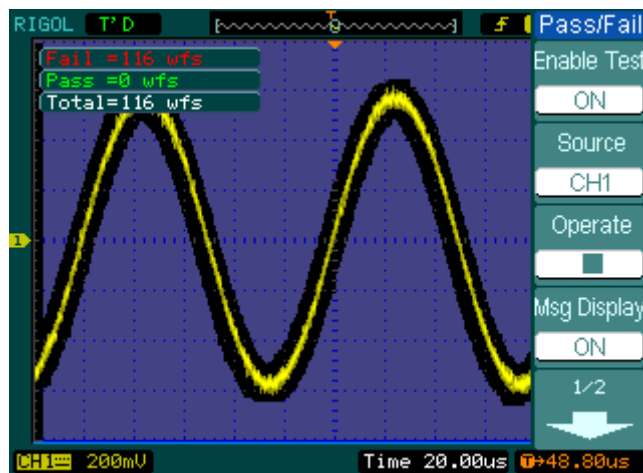

Figure 3-11 Waveform display

Chapter 4 Troubleshooting

1. After the oscilloscope is powered on, the screen remains dark (no display), please inspect the instrument following these steps:

- (1) Check the power cable connection.
- (2) Check if the power switch is turned on.
- (3) After the above inspection, restart the oscilloscope.
- (4) If the problem still remains, please contact **RIGOL** for help.

2. After the signal acquisition the waveform does not appear, please check according to the following steps:

- (1) Check if the probes are correctly connected with the signals.
- (2) Check if the probes are firmly connected to the channels.
- (3) Check if the probes are correctly connected with the object being tested.
- (4) Check if the circuit can generate signal at the test point (Connect the probe compensator output to an input channel to confirm whether the testing point has no signal or the input channel is in some troubles).
- (5) Repeat the acquisition.

3. The measurement result is 10 times higher or lower than the value expected.

Check if the probe attenuation is the same as the channel attenuation.

4. If the oscilloscope does not get a stable waveform display, please check according to the following steps:

- (1) Check the Trigger **Source** and notice if it is set to the channel in use.
- (2) Check the Trigger **Type**. Use "Edge" for normal signals, and use "Video" for VIDEO signals.
- (3) Switch the **Coupling** into **HF Rejection** or **LF Rejection** in order to filter the noise which disturbs trigger.

5. After pressing the **RUN/STOP button, the oscilloscope does not display any waveform on screen.**

Check whether the Trigger Mode is set to "Normal" or "Single" and see whether the trigger level is out of the signal range. If yes, set the trigger level in proper range by turning the **LEVEL** knob or pressing the **50%** button. Or set the Trigger Mode as "AUTO". Moreover, push **AUTO** button to display the waveform on screen.

6. After the Acquisition is set to "Averages" or Display Persistence is set ON, the waveform refreshes slowly.

It is normal in these settings.

7. The signal is displayed as ladder like waveform.

- (1) The time base maybe is too low. Turn the horizontal **SCALE** knob to increase horizontal resolution to improve the display.
- (2) Maybe the display Type is set to "Vectors" set it to "Dots" mode to improve the display.

Chapter 5 Specifications

All specifications apply to the DS1000CA Series Oscilloscopes unless noted otherwise. To meet these specifications, two conditions must first be met:

- The instrument must have been operating continuously for thirty minutes within the specified operating temperature.
- Must perform the Self Cal operation, accessible through the Utility menu, if the operating temperature changes by more than 5°C.

All specifications are guaranteed unless noted "typical".

Specifications

Acquisition		
Sampling Modes	Real-Time	Equivalent
Sampling Rate	2GSa/s ^[1] (single channel) 1GSa/s (each channel)	50GSa/s ^[2]
Averages	N time acquisitions, all channels simultaneously, N is selectable from 2, 4, 8, 16, 32, 64, 128 and 256	

Inputs	
Input Coupling	DC, AC, GND
Input Impedance	1M Ω ±2%, in parallel with 15pF±3pF 50 Ω ±2% ^[3]
Probe Attenuation Factors	1X, 5X, 10X, 50X, 100X, 500X, 1000X
Maximum Input Voltage	300V (DC+AC Peak, 1M Ω input impedance, 10X)
	5V (V _{RMS} , 50 Ω input impedance, BNC) ^[3]
Time delay between channel (typical)	500ps

50Ω	
With	DS1302CA, DS1202CA
Without	DS1062CA, DS1102CA

Horizontal	
Sample Rate Range	1Sa/s-2GSa/s (Real-Time), 50GSa/s (Equivalent) ^[2]
Waveform interpolation	Sin(x)/x
Record Length	Up to 10k samples for single channel, at 2GSa/s 5k samples for each channel
Scan speed Range (Sec/div)	1ns/div-50s/div, DS1302CA 2ns/div-50s/div, DS1102CA, DS1202CA 5ns/div-50s/div, DS1060CA 1-2-5 Sequence
Sample Rate and Delay Time Accuracy	±50ppm (over any≥1ms time interval)
Delta Time Measurement Accuracy	Single-shot: ±(1 sample interval + 50ppm × reading + 0.6 ns)

(Full Bandwidth)	>16 averages: $\pm(1\text{sample interval} + 50\text{ppm} \times \text{reading} + 0.4 \text{ ns})$
------------------	--

Measurements		
Cursor	Manual	Voltage difference between cursors (ΔV) Time difference between cursors (ΔT) Reciprocal of ΔT in Hertz ($1/\Delta T$)
	Track	Voltage value for Y-axis waveform Time value for X-axis waveform
	Auto	Cursors are visible for Automatic Measurement
Auto Measure	Vpp, Vamp, Vmax, Vmin, Vtop, Vbase, Vavg, Vrms, Overshoot, Preshoot, Freq, Period, Rise Time, Fall Time, +Width, -Width, +Duty, -Duty, Delay1→2 \ddagger , Delay1→2 \ddagger	

Vertical	
A/D converter	8-bit resolution, each channel samples simultaneously
Volts/div Range	1mV/div-10V/div at input BNC
Offset Range	$\pm 40\text{V}(205\text{mV/div}-10\text{V/div})$ $\pm 800\text{mV}(1\text{mV/div}-200\text{mV/div})$
Analog Bandwidth	60MHz(DS1062CA) 100MHz(DS1102CA) 200MHz(DS1202CA) 300MHz(DS1302CA)
Single-shot Bandwidth	60MHz(DS1062CA) 100MHz(DS1102CA) 200MHz(DS1202CA) 300MHz(DS1302CA)
Selectable Analog Bandwidth Limit (typical)	20MHz
Lower Frequency Limit (AC -3dB)	$\leq 5\text{Hz}$ (at input BNC)
Rise Time at BNC, typical	$<1.2\text{ns}$, $<1.7\text{ns}$, $<3.5\text{ns}$, $<5.8\text{ns}$, On 300MHz, 200MHz, 100MHz, 60MHz respectively
Dynamic range	$\pm 5\text{div}$
DC Gain Accuracy	1mV/div: $\pm 8\%$ (Normal or Average acquisition mode) 2mV/div-5mV/div: $\pm 4\%$ (Normal or Average acquisition mode)

RIGOL

	10mV/div-10V/div: $\pm 3\%$ (Normal or Average acquisition mode)
DC Measurement Accuracy, Average Acquisition Mode	Average of ≥ 16 Waveforms with vertical position at zero: $\pm(\text{DC Gain Accuracy} \times \text{reading} + 0.1\text{div} + 1\text{mV})$ Average of ≥ 16 Waveforms with vertical position not at zero: $\pm[\text{DC Gain Accuracy} \times (\text{reading} + \text{vertical position}) + (1\% \text{ of vertical position}) + 0.2\text{div}]$ Add 1mV for settings from 1mV/div to 200 mV/div Add 50mV for settings $> 200\text{mV/div}$ to 10V/div
Delta Volts Measurement Accuracy (Average Acquisition Mode)	Delta Volts between any two averages of 16 waveforms acquired under same setup and ambient conditions: $\pm(\text{DC Gain Accuracy} \times \text{reading} + 0.05 \text{ div})$
Overshoot	$< 20\%$

Trigger		
Trigger Sensitivity	0.1div-1.0div (adjustable)	
Trigger Level Range	Internal	± 6 divisions from center of screen
	EXT	$\pm 1\text{V}$
	EXT/5	$\pm 3\text{V}$
Trigger Level Accuracy (typical) applicable for the signal of rising and falling time $\geq 20\text{ns}$	Internal	$\pm(0.3\text{div} \times \text{V/div})$ (± 4 divisions from center of screen)
	EXT	$\pm(6\% \text{ of setting} + 40 \text{ mV})$
	EXT/5	$\pm(6\% \text{ of setting} + 200 \text{ mV})$
Trigger Offset	Normal mode: pre-trigger(262144/ sampling rate), delayed trigger 1s	
	Slow Scan mode: pre-trigger 6div, delayed trigger 6div	
Trigger Holdoff range	500ns-1.5s	
HF reject	100kHz $\pm 50\text{kHz}$	
LF reject	8kHz $\pm 20\%$	
Set Level to 50% (typical)	Input signal frequency $\geq 50\text{Hz}$	
Edge Trigger		
Edge trigger slope	Rising, Falling, Rising + Falling	
Pulse Trigger		
Trigger condition	$(>, <, =)$ Positive pulse, $(>, <, =)$ negative pulse	
Pulse Width range	20ns – 10s	

Video Trigger	
Video standard & line frequency	Support standard NTSC, PAL and SECAM broadcast systems. Line number range: 1-525 (NTSC) and 1-625 (PAL/SECAM)
Slope Trigger	
Trigger condition	(>, <, =) Positive slope, (>, <, =) negative slope
Time setting	20ns – 10s
Alternate Trigger	
Trigger on CH1	Edge, Pulse, Video, Slope
Trigger on CH2	Edge, Pulse, Video, Slope

NOTES:

- [1] Only one input channel is available when Sample rate is at 2GSa/s.
- [2] This is the highest specification, the specific specifications are as follows:
- | | |
|---------------------|---------|
| DS1302CA: | 50GSa/s |
| DS1202CA, DS1102CA: | 25GSa/s |
| DS1062CA: | 10GSa/s |
- [3] For DS1202CA and DS1302CA only.

General Specifications

Display	
Display Type	5.7 in. (145 mm) diagonal TFT Liquid Crystal Display
Display Resolution	320 horizontal ×RGB×234 vertical pixels
Display Color	64k color
Display Contrast (typical)	150:1
Backlight Brightness (typical)	300 nit

Probe Compensator Output	
Output Voltage (typical)	3 V _{pp} into ≥1 MΩ load
Frequency (typical)	1kHz

Power	
Supply Voltage	100 ~ 240 VAC _{RMS} , 45-440Hz, CAT II
Power Consumption	Less than 50VA
Fuse	2A, T rating, 250 V

Environmental	
Ambient Temperature	Operating 10°C ~ 40°C
	Non-operating -20°C ~ +60°C
Cooling Method	Fan force air flow
Humidity	+35°C or below: ≤90% relative humidity
	+35°C ~ +40°C: ≤60% relative humidity
Altitude	Operating 3,000 m or below
	Non-operating 15,000 m or below

Mechanical		
Size	Width	303mm
	Height	154mm
	Depth	133 mm
Heavy	Without package	2.4 kg
	Packaged	3.8 kg

IP Protection

IP2X

Calibration Interval

The calibration interval is one year

Chapter 6 Appendix

Appendix A: DS1000CA series Accessories

Standard Accessories

- Prob×2 (1.5m), 1:1, (10:1) Passive Probes
This Passive Probe is 6MHZ which belongs to 150v CATII when the power switch is in 1X.
This probe fit bandwidth upper limit which belongs to 300V CATII when the power switch is in 10X.
- A Power Cord that fits the standard of destination country
- Resource CD (including User's Guide)

Optional Accessories

- DS1000CA soft carrying case
- BNC Cable
- RS-232 Cable
- USB Cable
- USB-GPIB Adapter
- 50Ω Impedance Adapter

All accessories (standard and optional) are available by contacting your local **RIGOL** office.

Appendix B: Warranty

RIGOL warrants its products' mainframe and accessories in materials and workmanship within the warranty period. During the period concerned, **RIGOL** guarantees the free replacement or repair of products which are approved defective.

To get repair service or obtain a copy of the whole warranty statement, please contact with your nearest **RIGOL** sales and service office.

RIGOL do not provide any other warranty items except the one being provided by this summary and the warranty statement. The warranty items include but not being subjected to the hint guarantee items related to tradable characteristic and any particular purpose. **RIGOL** will not take any responsibility in cases regarding to indirect, particular and ensuing damage.

Appendix C: Maintenance

General Maintenance

Do not store or leave the instrument in where the instrument will be exposed to direct sunlight for long periods of time.

Caution

To avoid damages to the instrument or probes, do not expose them to liquids which have causticity.

Cleaning

Clean the instrument and probes often based on its operating conditions require. To clean the exterior surface, perform the following steps:

1. Disconnect the instrument from all power sources.
2. Clean the loose dust on the outside of the instrument and probes with a lint-free cloth (with a mild detergent and water). When clean the LCD, take care to avoid scarifying it.



WARNING

To avoid injury resulting from short circuit, make sure the instrument is completely dry before reconnecting into a power source.

Appendix D: Contact RIGOL

If you have any problem or requirement during using our products, please contact **RIGOL** Technologies, Inc. or the local distributors.

Domestic: Please call

Tel: (86-10) 8070 6688

Fax: (86-10) 8070 5070

Service & Support Hotline: 800 810 0002

9:00 am –5: 00 pm from Monday to Friday

Or by e-mail:

service@rigol.com

Or mail to:

RIGOL Technologies, Inc.

156# CaiHe Village, ShaHe Town, ChangPing District, Beijing, China

Post Code: 102206

Overseas: Contact the local **RIGOL** distributors or sales office.

For the latest product information and service, visit our website: www.rigolna.com

Index

50% 1-17

A

AC Coupling 2-6

AC Line 2-41

Acquisition 5-2

Alternative Trigger 2-36

Appendix 6-1

AUTO 2-88

Auto Trigger 2-41

Automatic Measurement 2-75

Average Acquisition 2-47

B

Bandwidth Limit 2-8

Blackman Window 2-16

C

Channel Coupling 2-6

Cleaning 6-3

Coarse/Fine 1-13

Cursor 2-81

Cursor Measurements 2-81

D

DC Coupling 2-6

Display 5-6

Display System 2-48

E

Edge Trigger 2-30

Envelope 2-47

Equivalent Sampling 2-47

Ext and Ext/5 2-41

F

Factory Setup 2-57

FFT 2-15

FORCE 1-17

Front panel 1-3

Functional check 1-8

G

GND Coupling 2-7

H

Hamming Window 2-16

Hanning Window 2-16

HF Reject 2-42

Horizontal 5-2

I

I/O setup 2-60

Inputs 5-2

Instant Execute Key 2-88

Invert a waveform 2-13

L

Language 2-61

LF Reject 2-42

M

Math 2-14

Measurements 5-3

Normal Trigger 2-42

N

Nyquist Frequency2-17

P

Power5-6

Pretrigger2-42

Probe Attenuation.....2-9

Probe compensation1-10

Probe Compensator5-6

Pulse Trigger2-31

R

Random Noise3-4

Realtime Sampling2-47

Rectangle Window2-16

REF.....2-18

RUN/STOP2-88

S

Sampling System2-44

Save and Recal 2-1

Self- Calibration 2-71

Single Trigger 2-42

Slope Trigger 2-34

Sync Pulses..... 2-33

T

Trigger 5-4

Trigger Settings 2-39

Trigger System 2-29

U

UTILITY..... 2-58

V

Vertical 5-3

Vertical Window 1-12

Video Signal..... 3-11

Video Trigger 2-32